







J
F 3225 K 471 G2

FRX®

4032

贴片尺寸:
SMD Size:
3225≈8.2×6.3mm
4032≈11.0×8.2mm

15寸料盘卷装:
15" Reel packing:
3225: 1820PCS/reel
4032: 1500PCS/reel

压敏电压公差: ±10%
Varistor voltage

压敏电压 (V1mA): $47 \times 10^1 = 470V$

Varistor voltage tolerance: ±10%

Varistor voltage (V1mA): $47 \times 10^1 = 470V$

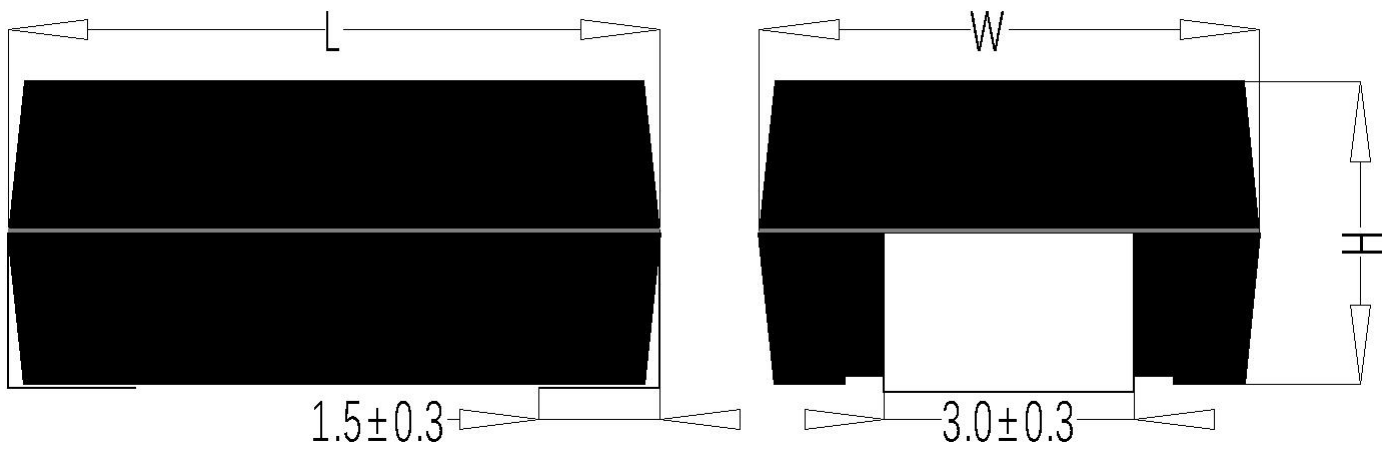



, AV

€





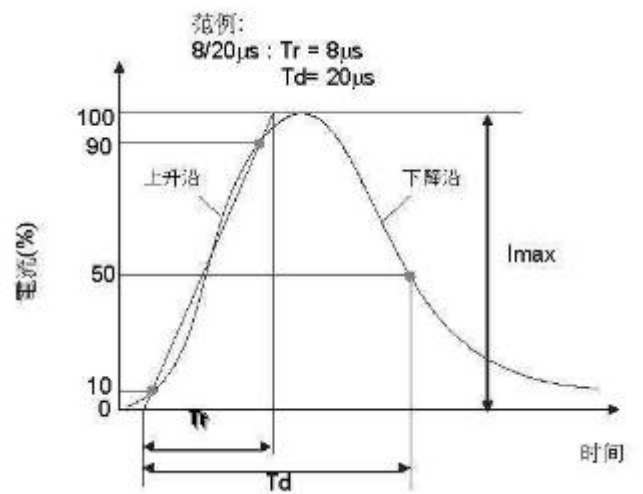
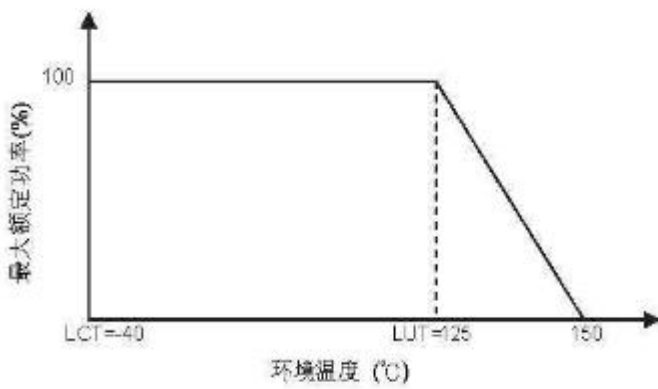

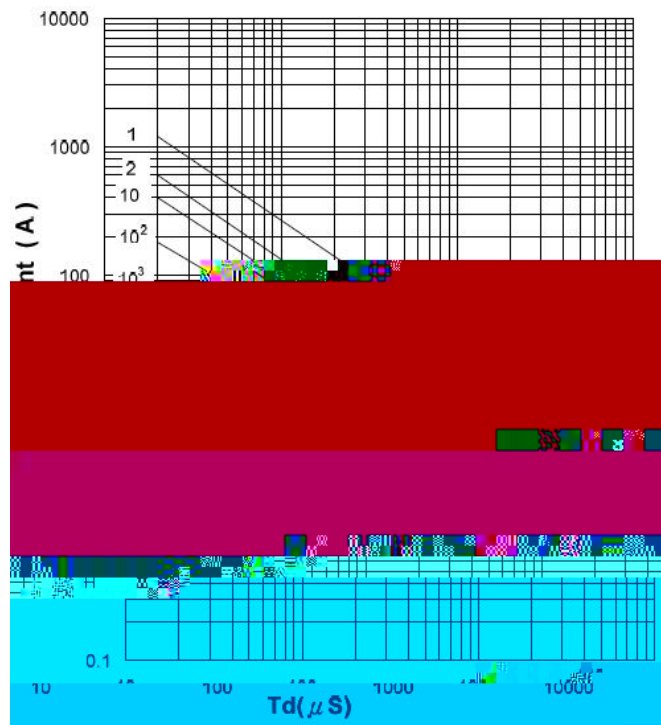
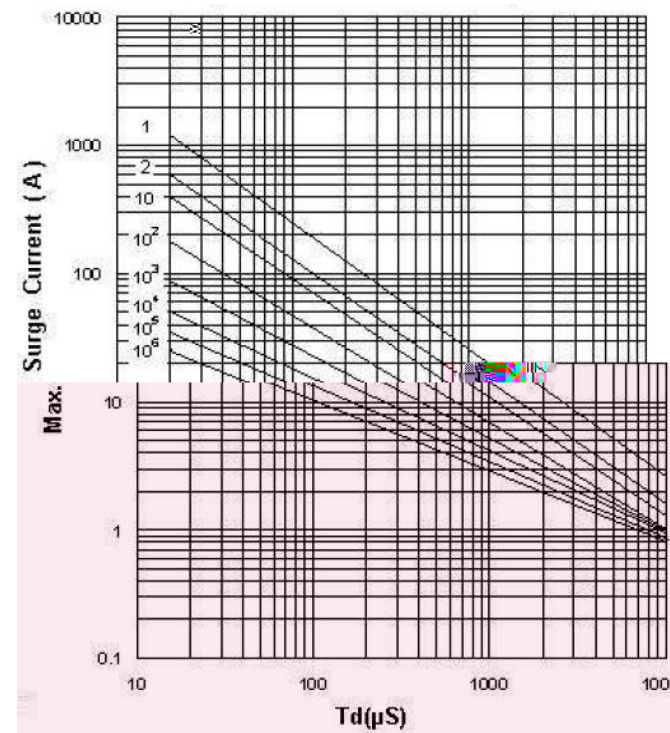
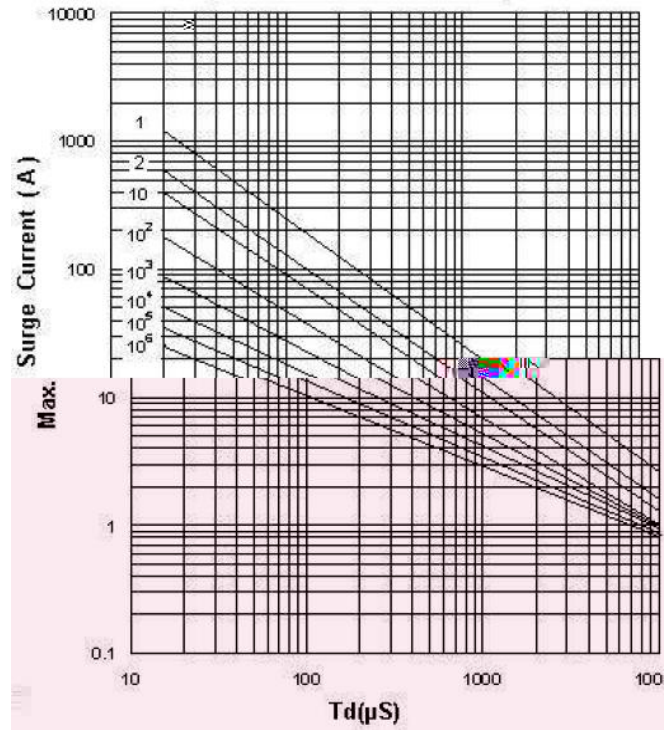
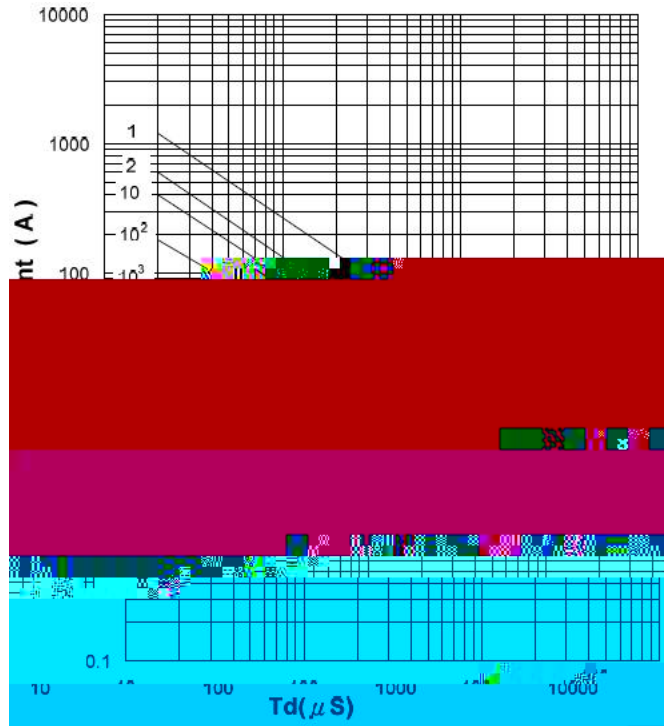

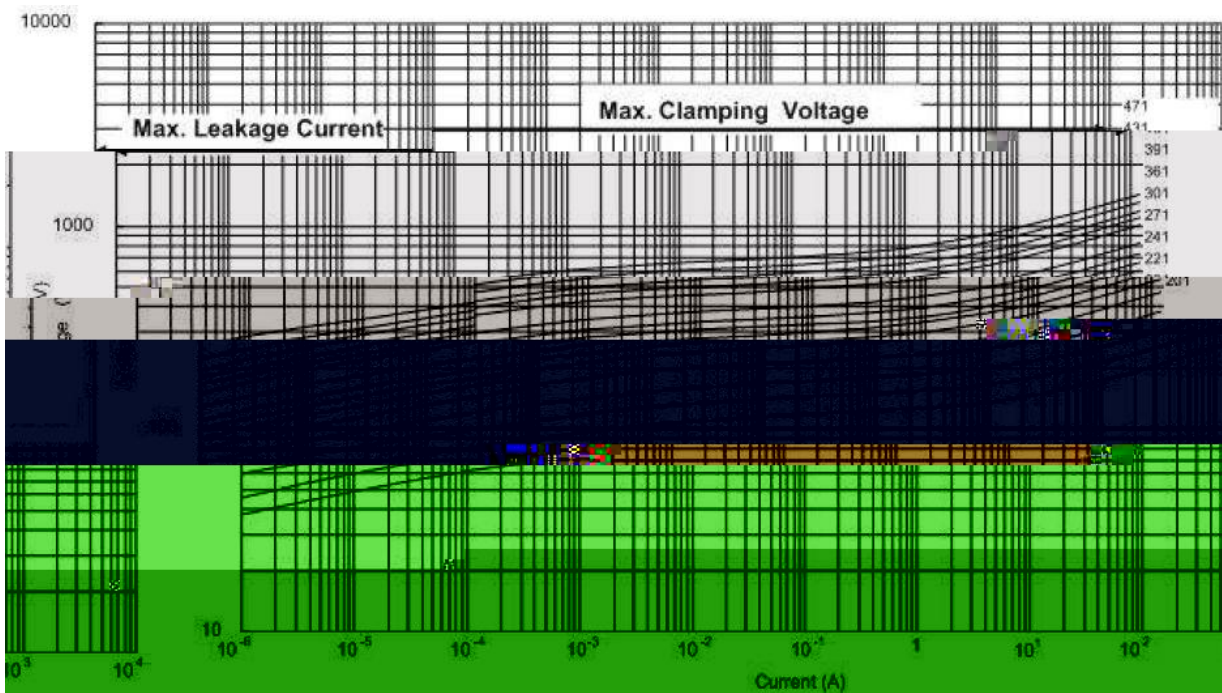
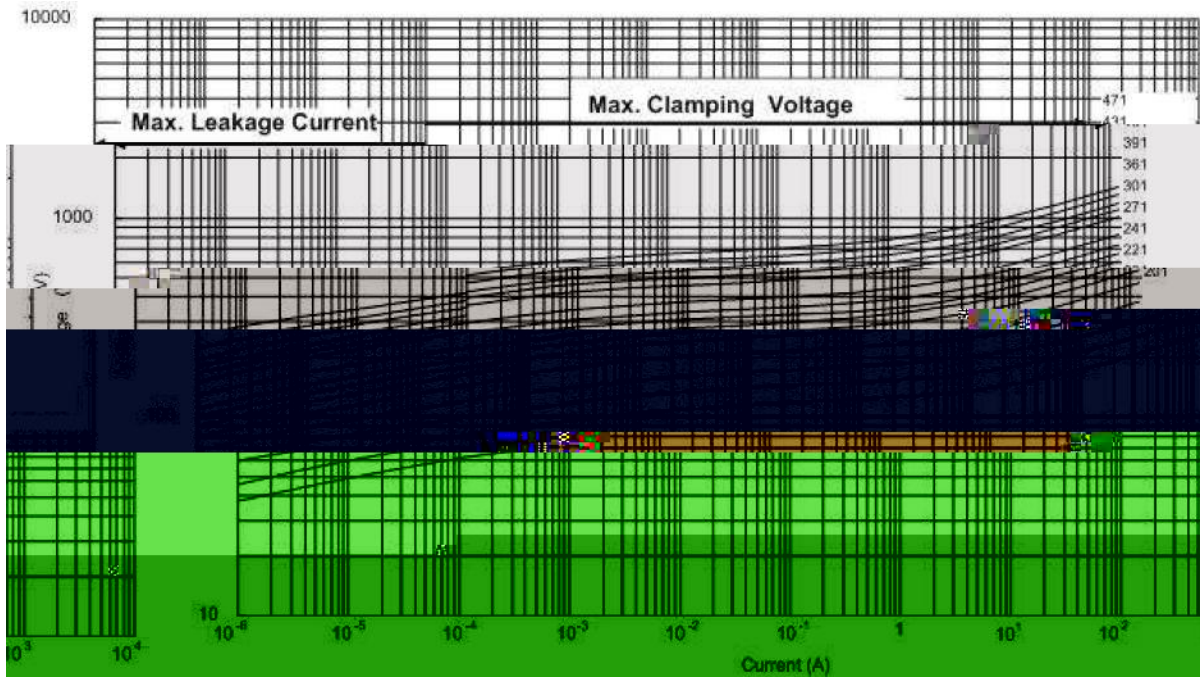

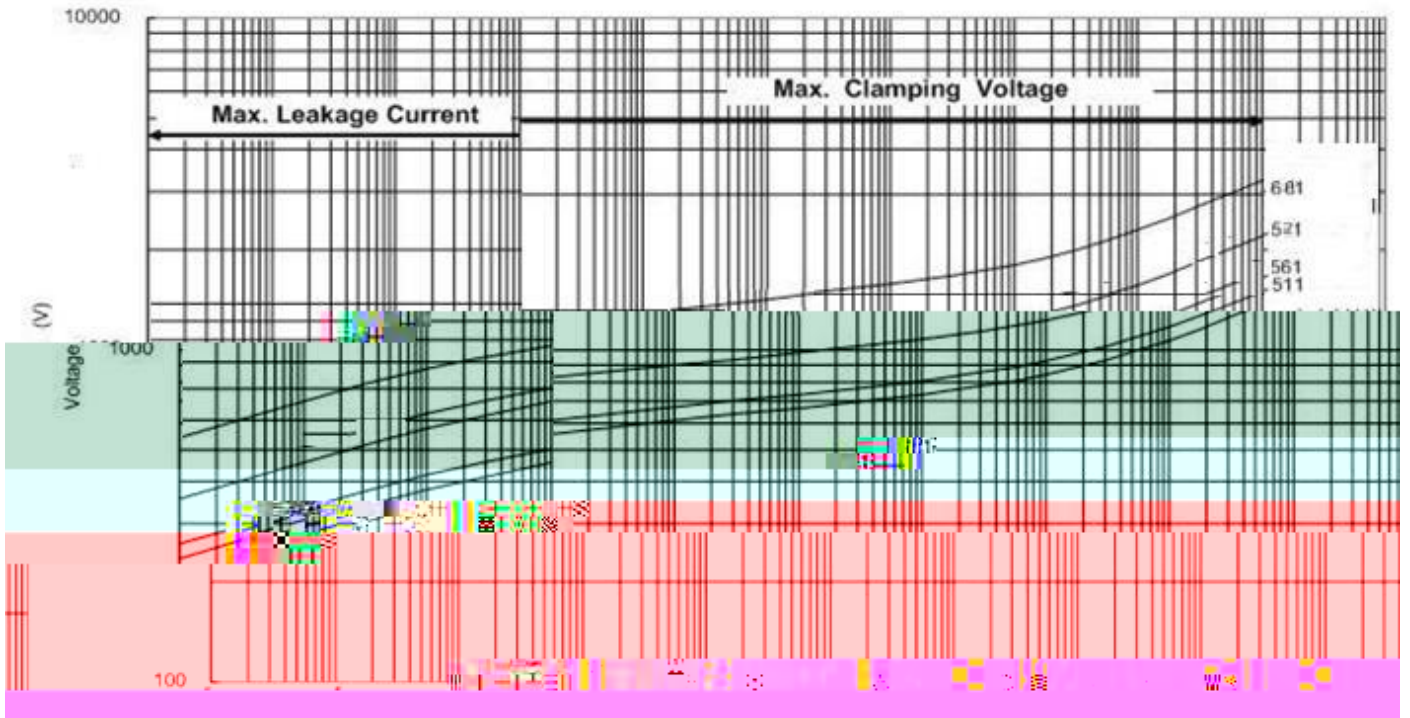

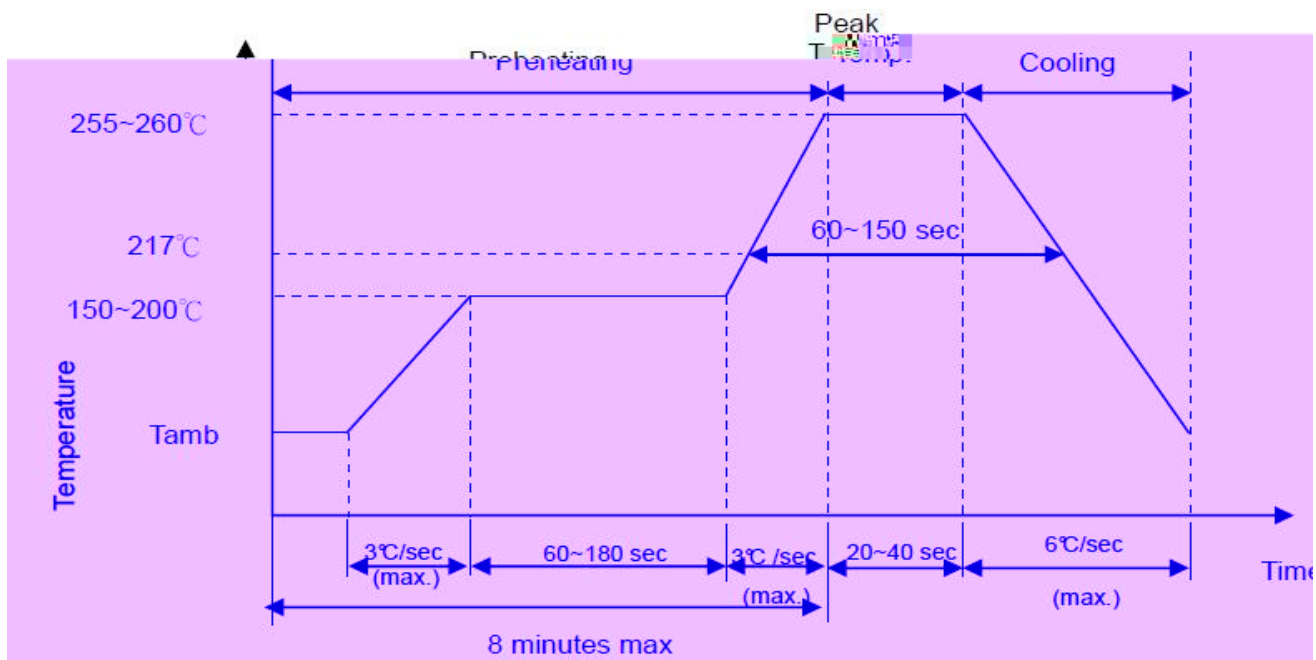
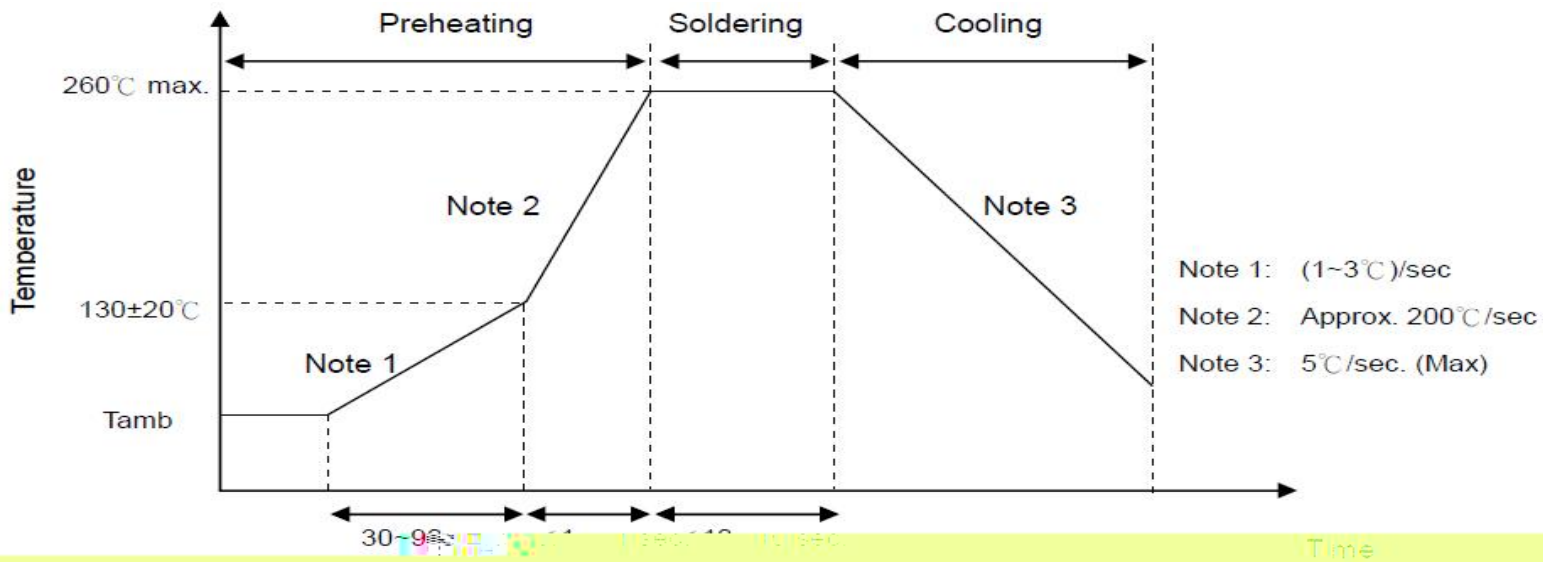



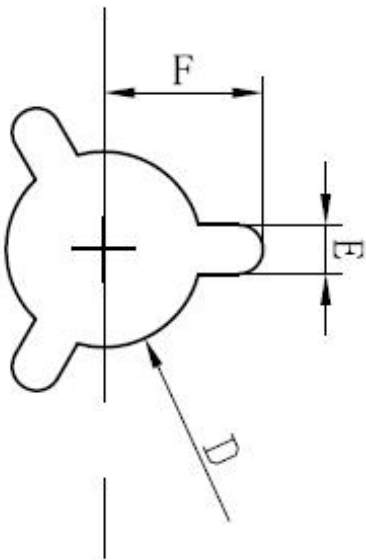
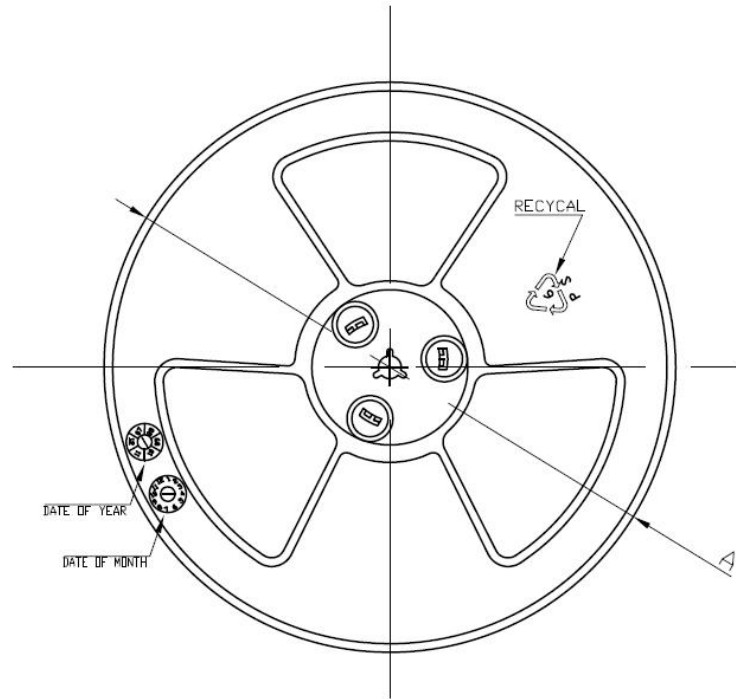



(

