

## Surface Mount General Purpose Rectifier

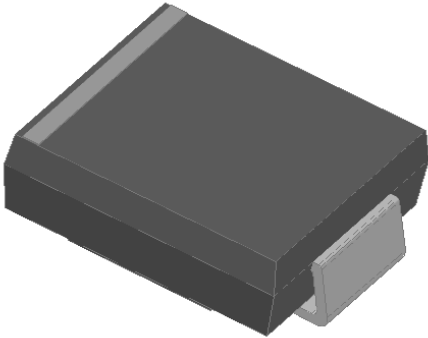

### Features

- Low profile package
- Ideal for automated placement
- Glass passivated chip junction
- High forward surge capability
- Meets MSL level 1, per J-STD-020, LF maximum peak of 260 °C

### Typical Applications

For use in general purpose rectification of power supplies, inverters, converters, and freewheeling diodes for consumer, and telecommunication.

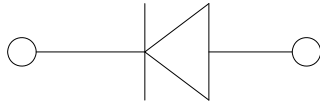

### Mechanical Data

- Package: DO-214AB (SMC)
- Molding compound meets UL 94 V-0 flammability rating, RoHS-compliant, halogen-free
- Terminals: Tin plated leads, solderable per J-STD-002 and JESD22-B102
- Polarity: Color band denotes the cathode end

### Maximum Ratings (T<sub>a</sub>=25°C Unless otherwise specified)

| PARAMETER   | SYMBOL           | UNIT             | GS10A      | GS10B | GS10D | GS10G | GS10J | GS10K | GS10M |
|---|------------------|------------------|------------|-------|-------|-------|-------|-------|-------|
| Device marking code   |                  |                  | GS10A      | GS10B | GS10D | GS10G | GS10J | GS10K | GS10M |
| Maximum Repetitive peak reverse voltage   | V <sub>RRM</sub> | V                | 50         | 100   | 200   | 400   | 600   | 800   | 1000  |
| Maximum RMS Voltage   | V <sub>RMS</sub> | V                | 35         | 70    | 140   | 280   | 420   | 560   | 700   |
| Maximum DC Blocking Voltage   | V <sub>DC</sub>  | V                | 50         | 100   | 200   | 400   | 600   | 800   | 1000  |
| Average Rectified Output Current<br>@60Hz sine wave, Resistance load, TL (FIG.1)              | I <sub>O</sub>   | A                | 10         |       |       |       |       |       |       |
| Forward Surge Current (Non-repetitive)<br>@60Hz Half-sine wave, 1 cycle, T <sub>j</sub> =25°C | I <sub>FSM</sub> | A                | 200        |       |       |       |       |       |       |
| Forward Surge Current (Non-repetitive)<br>@1ms, square wave, 1 cycle, T <sub>j</sub> =25°C    |                  |                  | 400        |       |       |       |       |       |       |
| Current squared time<br>@1ms t 8.3ms T <sub>j</sub> =25°C                                     | I <sup>2</sup> t | A <sup>2</sup> s | 166        |       |       |       |       |       |       |
| Storage Temperature   | T <sub>stg</sub> |                  | -55 ~ +150 |       |       |       |       |       |       |
| Junction Temperature  | T <sub>j</sub>   |                  | -55 ~ +150 |       |       |       |       |       |       |

### Electrical Characteristics (T<sub>a</sub>=25°C Unless otherwise specified)

| PARAMETER   | SYMBOL         | UNIT | TEST CONDITIONS   | GS10A | GS10B | GS10D | GS10G | GS10J | GS10K | GS10M |
|---|----------------|------|---|-------|-------|-------|-------|-------|-------|-------|
| Maximum instantaneous forward voltage                   | V <sub>F</sub> | V    | I <sub>FM</sub> =10A                                      | 1.1   |       |       |       |       |       |       |
| Maximum DC reverse current at rated DC blocking voltage | I <sub>R</sub> | μA   | T <sub>j</sub> =25  | 5     |       |       |       |       |       |       |
|   |                |      | T <sub>j</sub> =125                                       | 100   |       |       |       |       |       |       |
| Typical junction capacitance                            | C <sub>j</sub> | pF   | Measured at 1MHz and Applied Reverse Voltage of 4.0 V.D.C | 55    |       |       |       |       |       |       |



# GS10A THRU GS10M

## Thermal Characteristics (T<sub>a</sub>=25°C Unless otherwise specified)

| PARAMETER                  | SYMBOL   | UNIT | GS10A | GS10B | GS10D | GS10G | GS10J | GS10K | GS10M |
|----------------------------|----------|------|-------|-------|-------|-------|-------|-------|-------|
| Typical Thermal resistance | R J-A(1) | /W   | 50    |       |       |       |       |       |       |
|                            | R J-L(1) |      | 10    |       |       |       |       |       |       |
|                            | R J-C(1) |      | 8     |       |       |       |       |       |       |

Note(1)

Thermal resistance from junction to ambient and from junction to lead mounted on P.C.B. with 0.6" x 0.6" (16 mm x 16 mm) copper pad areas

## Ordering Information (Example)

| PREFERRED P/N | PACKAGE CODE | UNIT WEIGHT(g)    | MINIMUM PACKAGE(pcs) | INNER BOX QUANTITY(pcs) | OUTER CARTON QUANTITY(pcs) | DELIVERY MODE |
|---------------|--------------|-------------------|----------------------|-------------------------|----------------------------|---------------|
| GS10A-GS10M   | F1           | Approximate 0.261 | 3000                 | /                       | 42000                      | 13" reel      |

## Characteristics(Typical)

FIG.1: I<sub>o</sub>-T<sub>L</sub> Curve

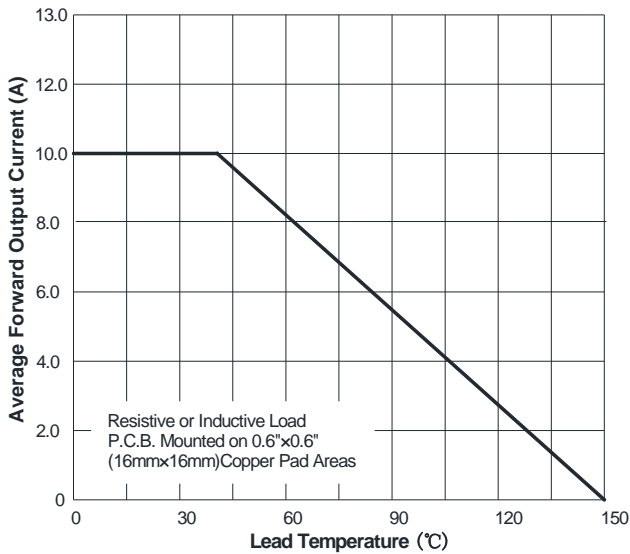

FIG.2: Forward Surge Current Capability

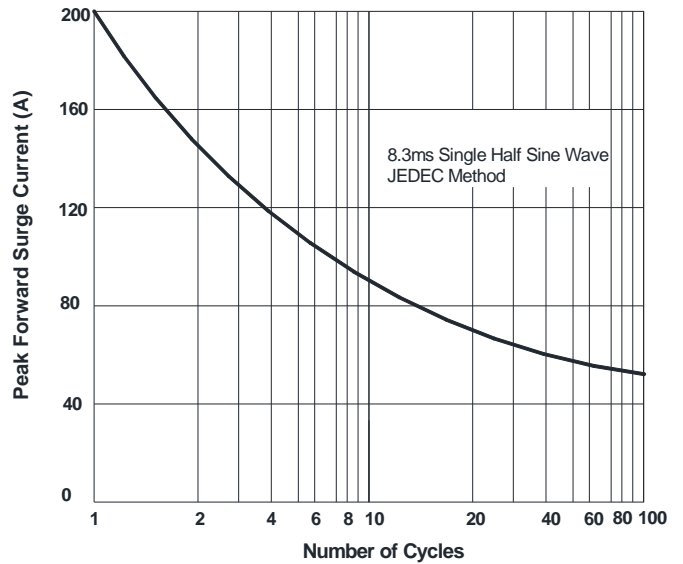

FIG.3: Typical Forward Voltage

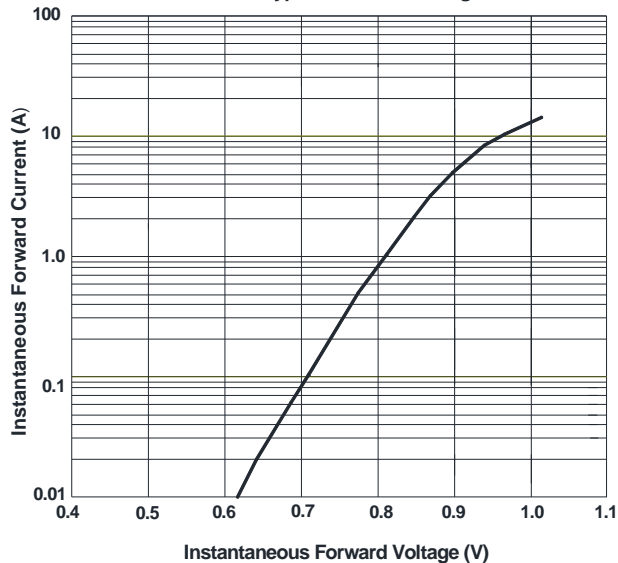
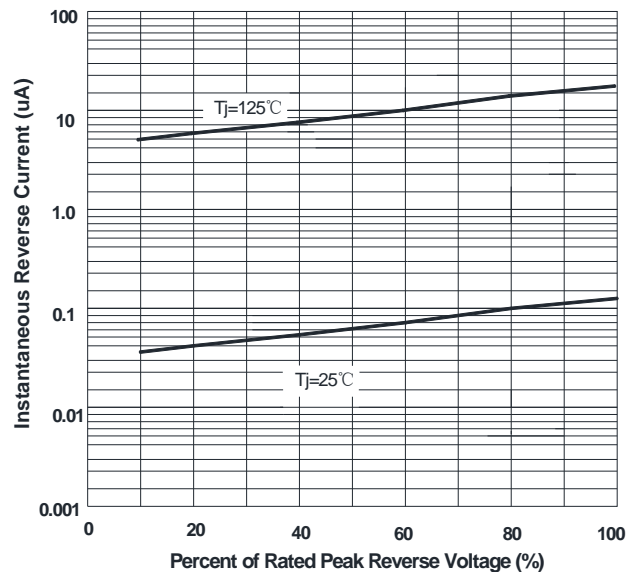

FIG.4: Typical Reverse Characteristics





# GS10A THRU GS10M

## Outline Dimensions

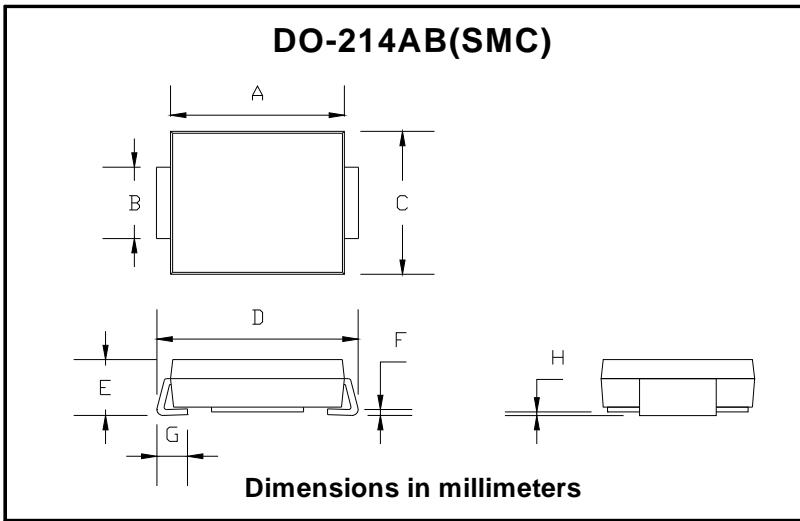

| DO-214AB (SMC) |      |      |
|----------------|------|------|
| Dim            | Min  | Max  |
| A              | 6.60 | 7.11 |
| B              | 2.85 | 3.27 |
| C              | 5.59 | 6.22 |
| D              | 7.75 | 8.13 |
| E              | 1.99 | 2.61 |
| F              | 0.15 | 0.31 |
| G              | 0.76 | 1.52 |
| H              | 0.05 | 0.20 |

## Suggested pad layout

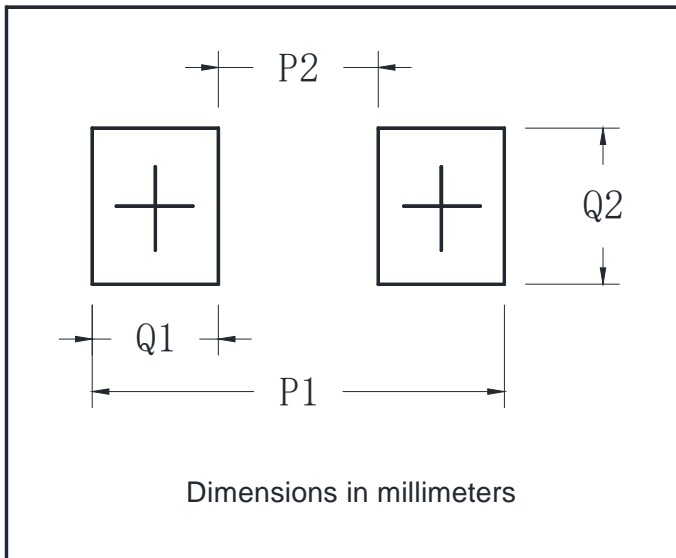

| DO-214AB (SMC) |      |
|----------------|------|
| Dim            | Min  |
| P1             | 9.9  |
| P2             | 3.84 |
| Q1             | 3.03 |
| Q2             | 3.82 |



## GS10A THRU GS10M

---

### Disclaimer

The information presented in this document is for reference only. Yangzhou Yangjie Electronic Technology Co., Ltd. reserves the right to make changes without notice for the specification of the products displayed herein to improve reliability, function or design or otherwise.

The product listed herein is designed to be used with ordinary electronic equipment or devices, and not designed to be used with equipment or devices which require high level of reliability and the malfunction of which would directly endanger human life (such as medical instruments, transportation equipment, aerospace machinery, nuclear-reactor controllers, fuel controllers and other safety devices), Yangjie or anyone on its behalf, assumes no responsibility or liability for any damages resulting from such improper use of sale.

This publication supersedes & replaces all information previously supplied. For additional information, please visit our website [http:// www.frxelec.com](http://www.frxelec.com) , or consult your nearest Yangjie's sales office for further assistance.