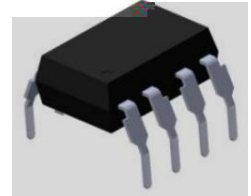
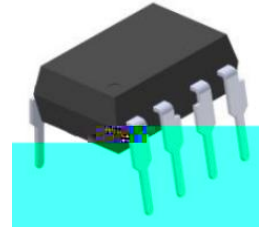

一级代理商：

深圳市弗瑞鑫电子有限公司

地址：深圳市宝安区西乡大道302号金源商务大厦B座三楼

frxelec

1. Features



2. Instructions

3. Application Range

-
-
-
-

4. Functional Diagram

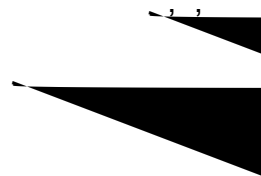
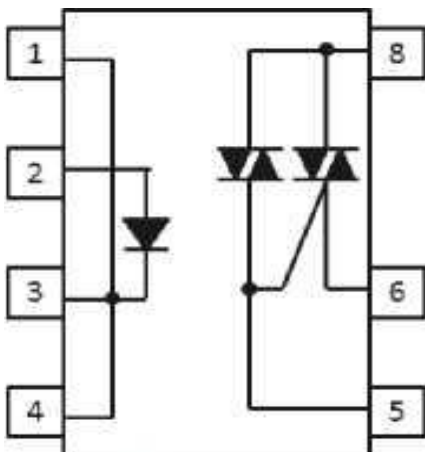

5. Absolute Maximum Ratings (Ta=25°C)

Parameter		Symbol	Rated Value	Unit

*

6. Recommended Operating Conditions

Parameter		Symbol	Min	Typ.*	Max	Unit	Condition
Input							
Output							
Transfer Characteristics							

7. Order Information

Part Number

OR-X223U-Y-Z

Note

Option	Description	Packing quantity

8. Naming Rule

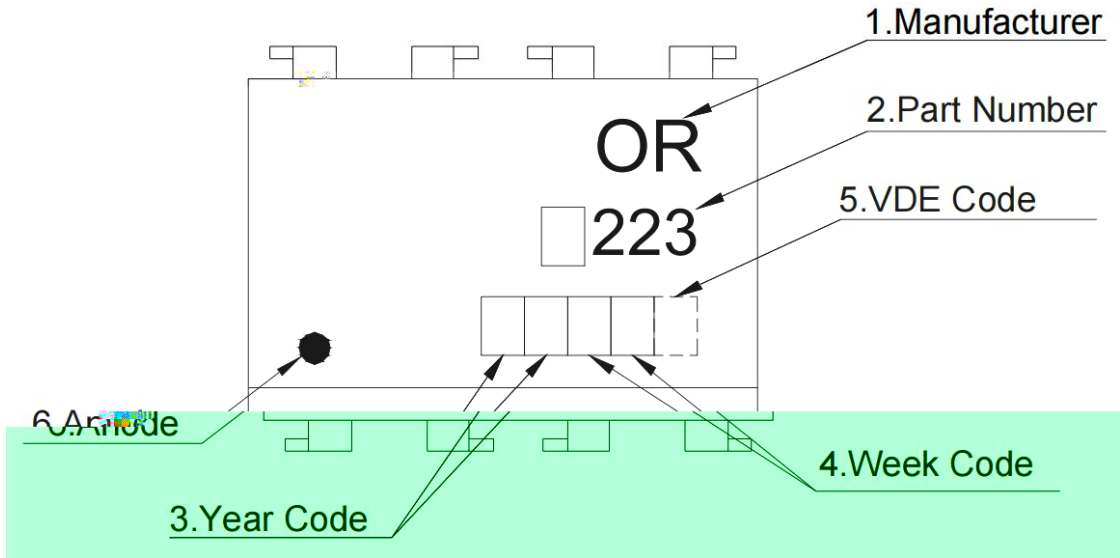

9. Outer Dimension

1 OR-X223

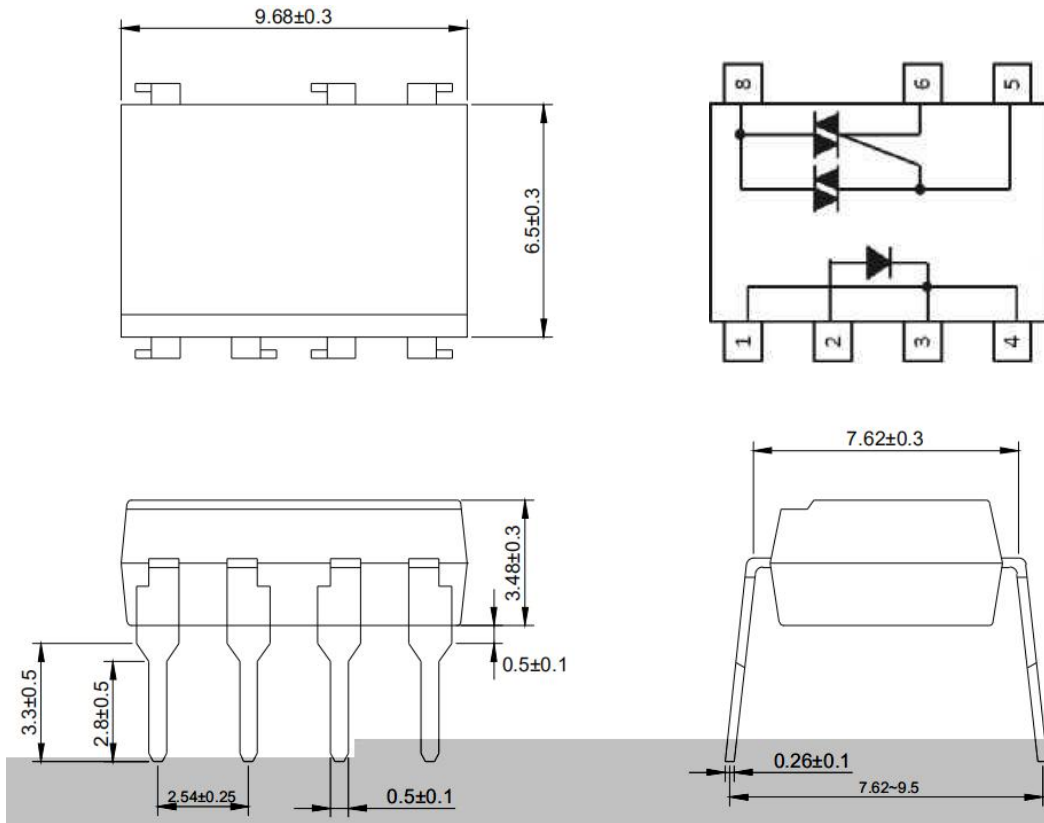

2 OR-X223M

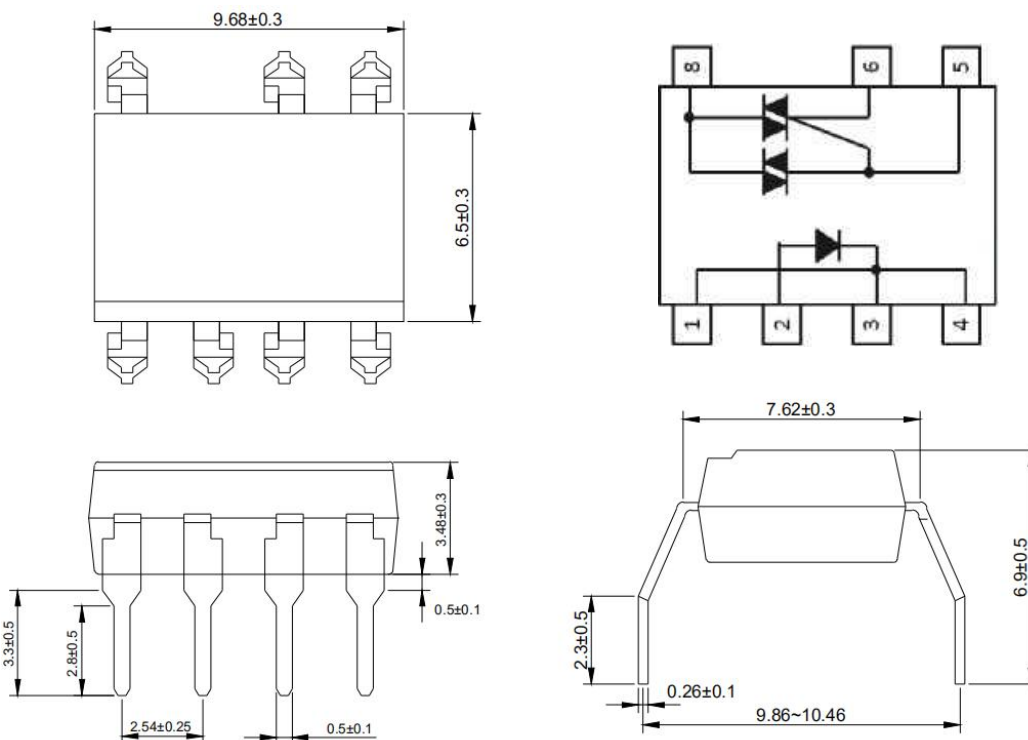

3 OR-X223S

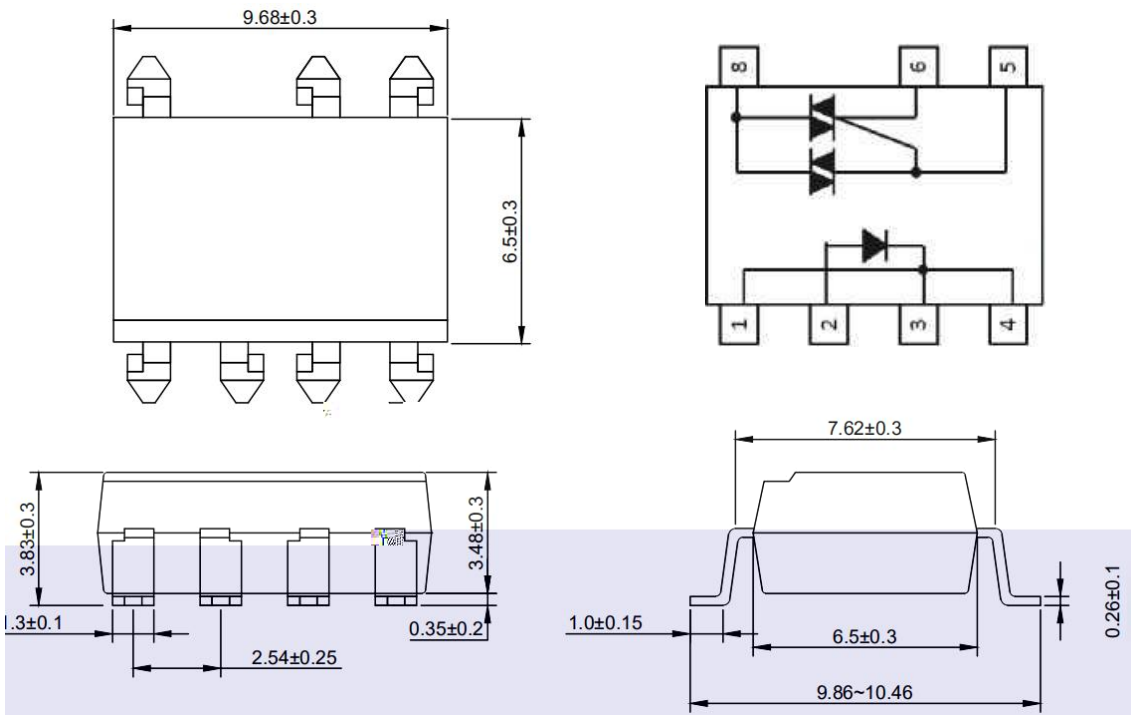

12 Recommended Foot Print Patterns (Mount Pad)

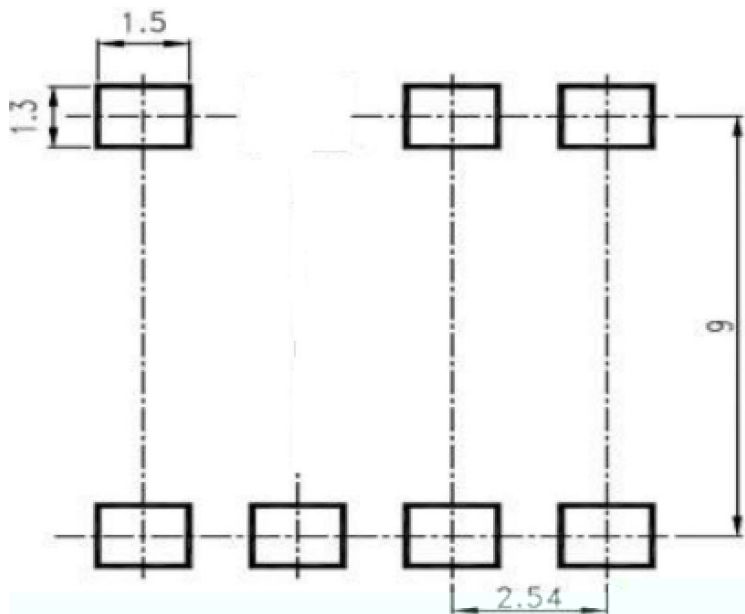

10. Taping Dimensions

1 OR-X223-TA

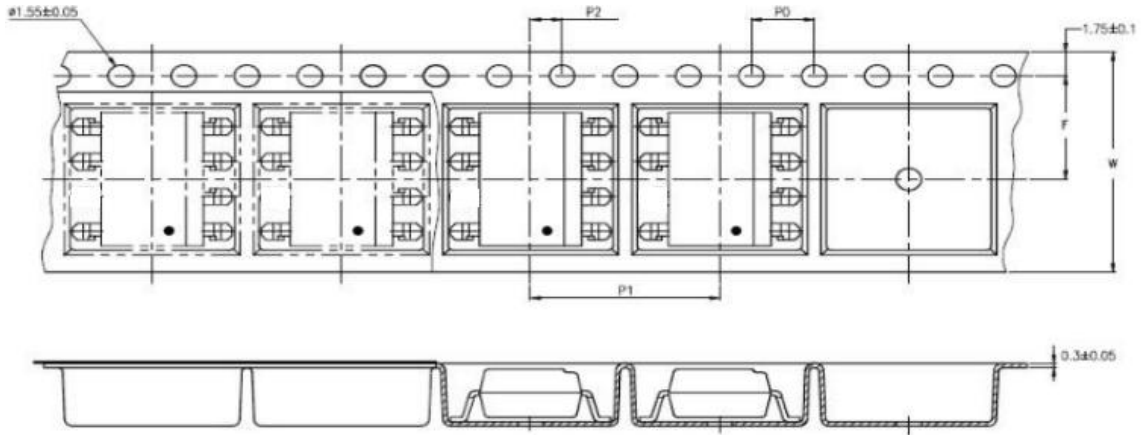

2 OR-X223-TA1

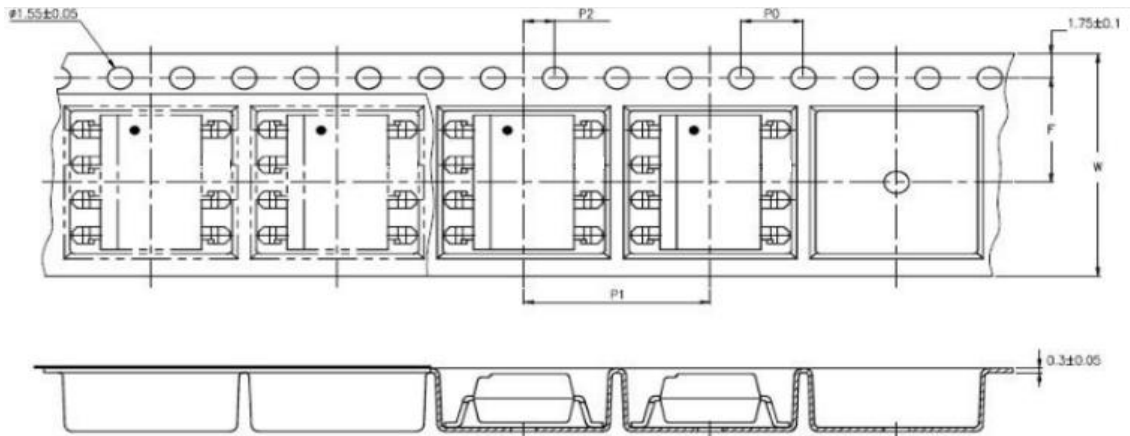

2

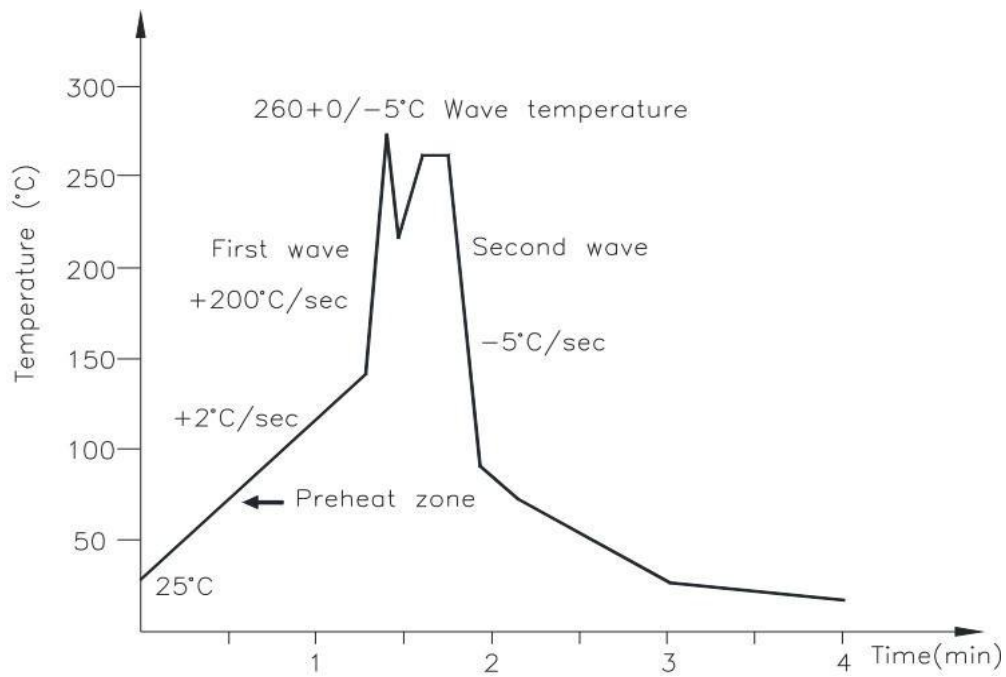

3

Temperature	380+ 0/-5°C
Time	3 sec max

13. Characteristics Curve

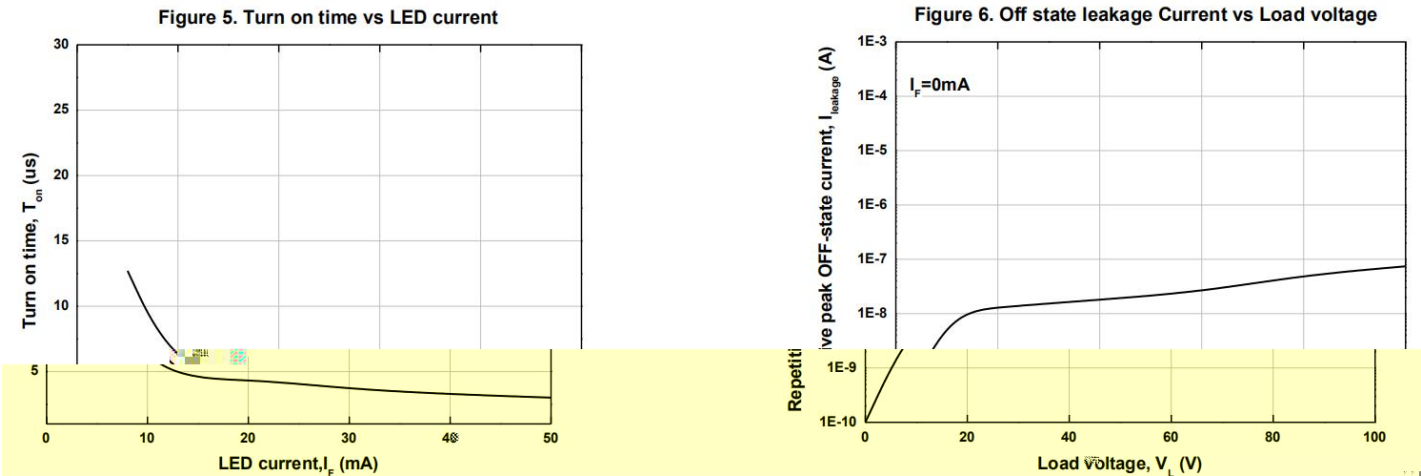
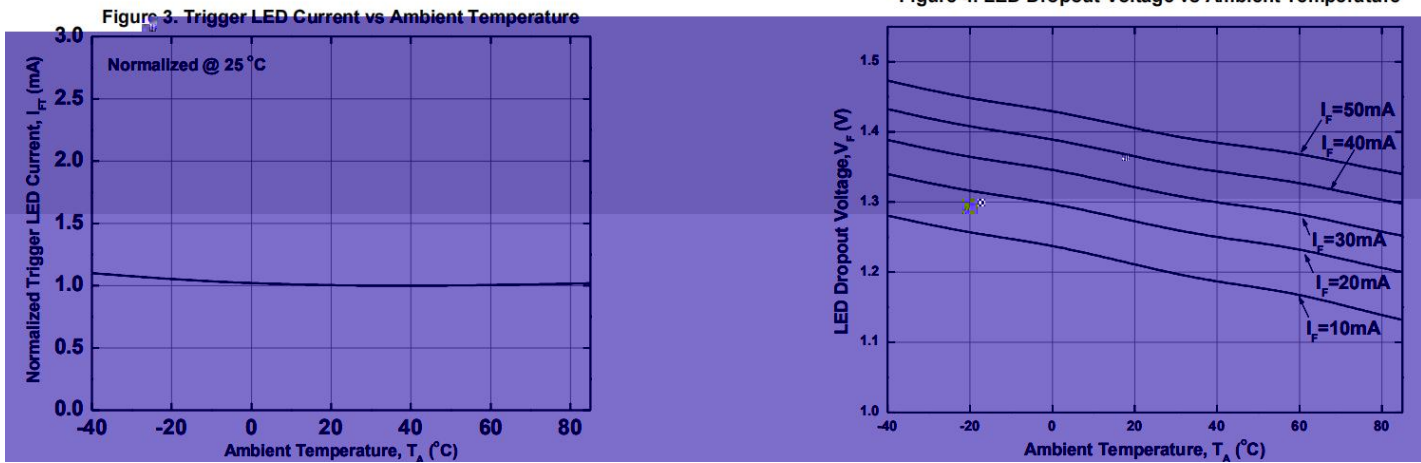
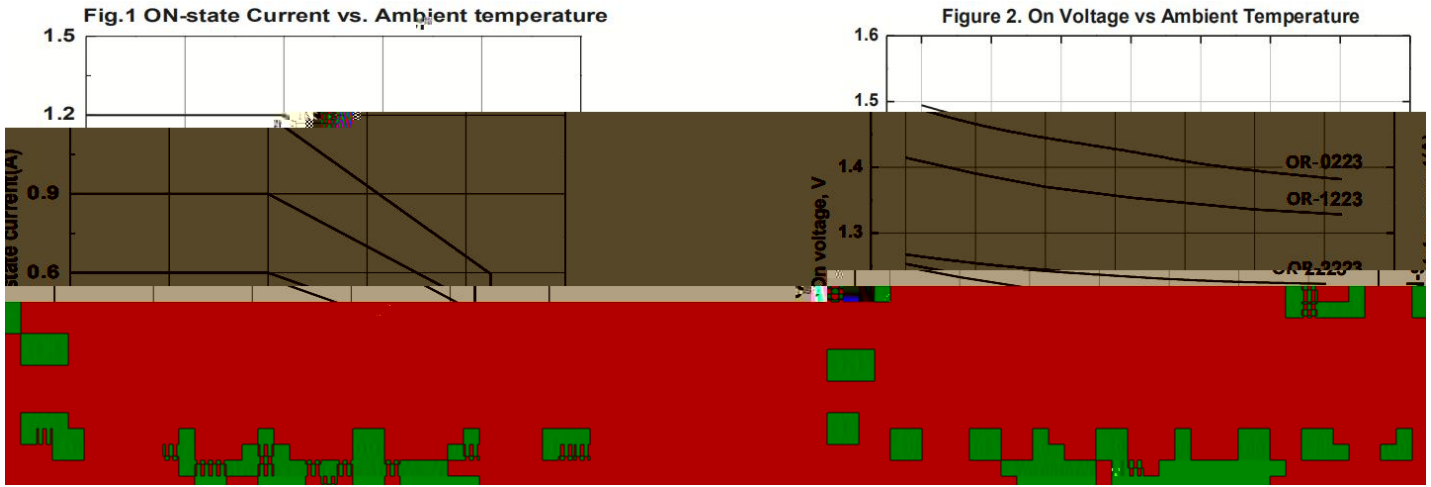

Figure 7. Holding Current vs. Ambient Temperature

