

规格承认书

—

prepare	
check	
approve	



TRX 特锐祥
专 注 电 容 器 11 年

TRX电容一级代理商
深圳市弗瑞鑫电子有限公司

Add: 深圳市宝安区西乡大道302号金源商务大厦B座3楼

Tel: 0755-29563634

Fax: 0755-27447020

SMD- 2

SMD 2 . .

/N

/D

/E

/P

	SMD- 2 SMD 2 . .		
	/N		/D
	/E		/P

	SMD- 2 SMD 2 . .		
	/N		/D
	/E		/P

1. /P N

T B 2 102 M E
 ① ② ③ ④ ⑤ ⑥

①

	SMD- 2 SMD 2 . .		
	/N		/D
	/E		/P

3. /D



 TRX 专注电容器廿年	SMD- 2 SMD 2 . .		
	/N		/D
	/E		/P

4. /C

5. /P



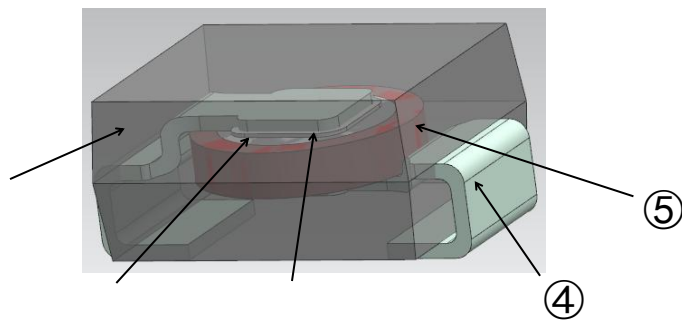

①		
②		
③		
④		
⑤		

SMD- 2
SMD 2 . .

/N

/D

/E

	SMD- 2 SMD 2 . .		
	/N		/D
	/E		/P

/

°
°C

°

°

°

/

7. /P



SMD- 2
SMD 2 . .

/N

/D

/E

/P

					±
		±			
		±			
		±			
		±			

SMD- 2
SMD

 TRX 专注电容器廿年	SMD- 2 SMD 2 . .		
	/N		/D
	/E		/P

			± ±
			± ±
			± ±
			± ±
			± ±
			± ±
			± ±

8. /C

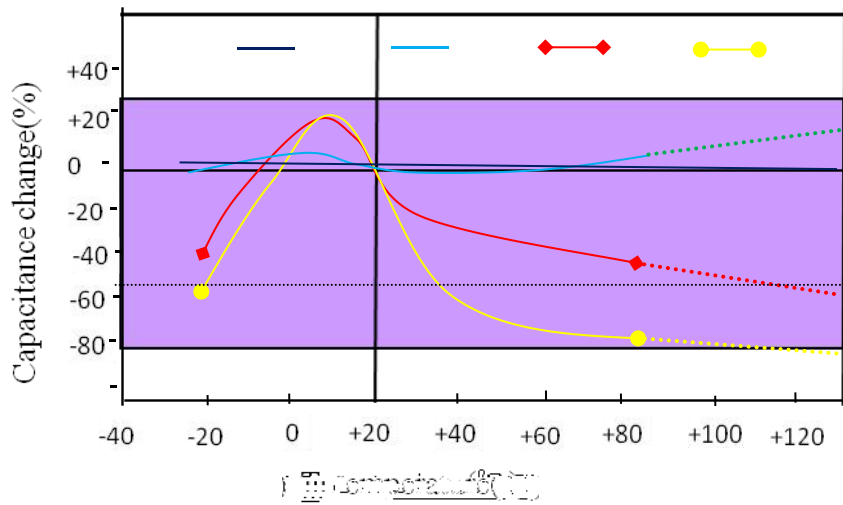

	SMD- 2 SMD 2 . .		
	/N		/D
	/E		/P

9. /C

R HS H.F.
REACH

10. /S

(1)

(2)

(3)

/
/

(4)

x

 TRX 专注电容器廿年	SMD- 2		
	SMD 2 . .		
	/N		/D
	/E		/P

11. /P P
/

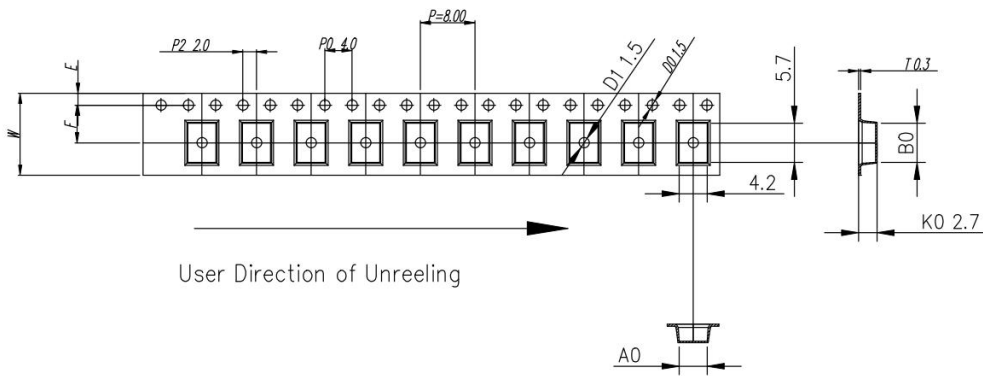

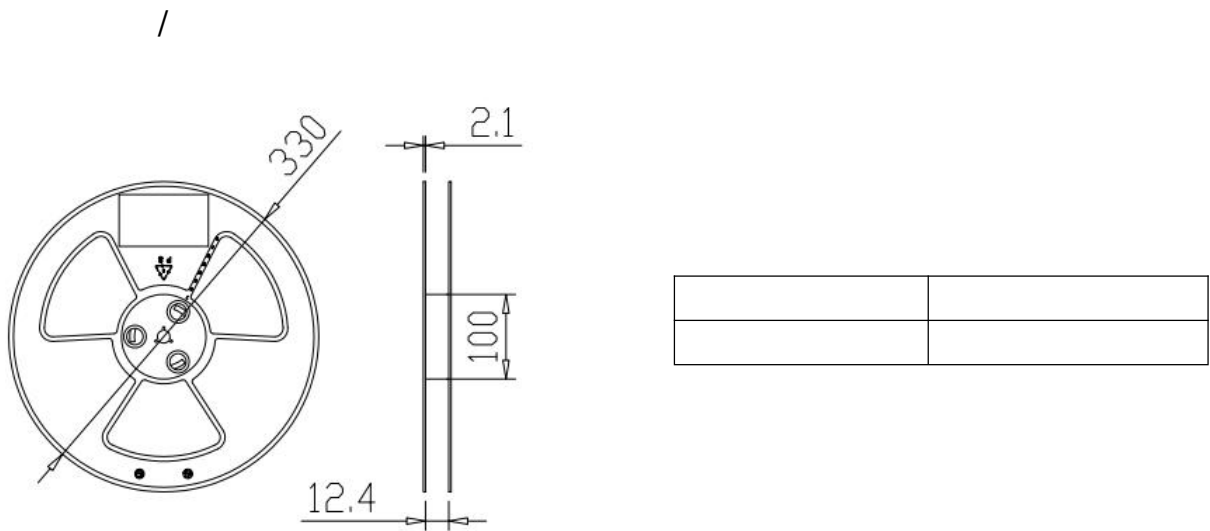

ITEM	W	A0	B0	K1	K0	P	F	E	D0	D1	P0	P2	T
DIM	12.0	$4.20^{+0.30/-0.30}$	$5.70^{+0.10/-0.10}$	--	$2.70^{+0.10/-0.10}$	$8.00^{+0.10/-0.10}$	$5.50^{+0.10/-0.10}$	$1.75^{+0.10/-0.10}$	$\phi 1.5^{+0.10/-0.00}$	$\phi 1.5^{+0.10/-0.10}$	$4.0^{+0.10/-0.10}$	$2.0^{+0.10/-0.10}$	$0.30^{+0.05/-0.05}$
ALTERNATE													

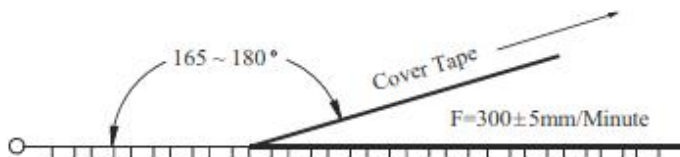

/

Item	Data	Remark
Cover tape adhesion	10 ~ 100g	Carrier tape and cover tape open angle 165 ~ 180° F=300±5mm/minute



 TRX 专注电容器廿年	SMD- 2 SMD 2 . .		
	/N		/D
	/E		/P

/ -

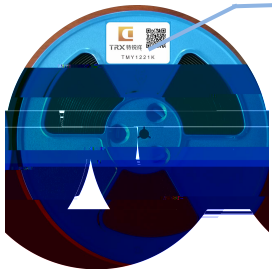

标签



料号

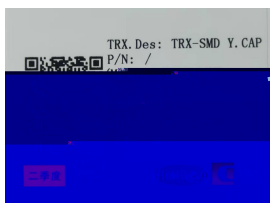

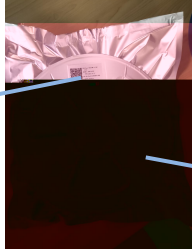

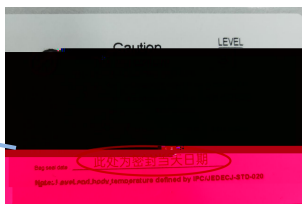



/O -







图示 / 图示 / 图示 /



/P :



/



/





" "

R

	SMD- 2 SMD 2 . .		
	/N		/D
	/E		/P

12. /A

①

②