

IGBT Modules

VCES

IC

Applications

Features

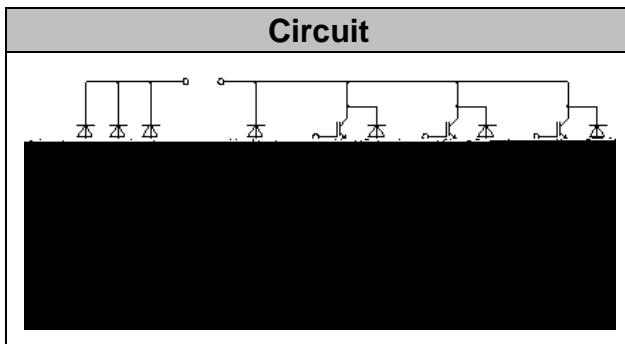

IGBT- inverter

Absolute Maximum Ratings

Parameter	Symbol	Conditions	Value	Unit

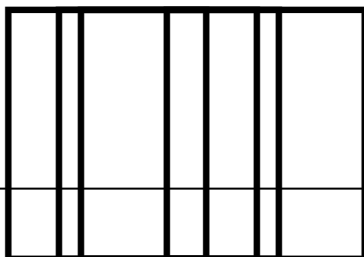

IGBT- inverter

Characteristic values

Parameter	Symbol	Condition	Value		Unit
			Min.	Typ.	

--	--	--	--	--



O I 37R34R4

RoHS
COMPLIANT

Diode-inverter Absolute Maximum Ratings

Parameter	Symbol	Conditions	Value		Unit
			Min.	Max.	

Characteristic values

Parameter	Symbol	Conditions	Value			Unit
			Min.	Typ.	Max.	

--	--	--	--	--



O I 37R34R4

RoHS
COMPLIANT

**Diode-Brake-Chopper
Absolute Maximum Ratings**

Reference

Symbol

Conditions

Value

Unit

RI Ep U E ~ % T T @ " E d 9

--	--	--	--	--



O I 37R34R4

RoHS
COMPLIANT

Diode-Rectifier
Absolute Maximum Ratings

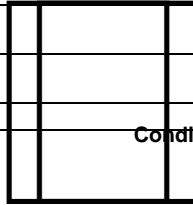

Parameter	Symbol	Conditions	Value	Unit

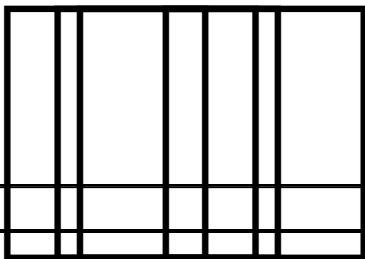



O I 37R34R4

RoHS
COMPLIANT

Module Characteristics

Parameter	Symbol	Conditions	Value			Unit
			Min.	Typ.	Max.	

--	--	--	--	--



--	--	--	--	--	--

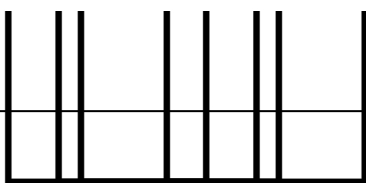
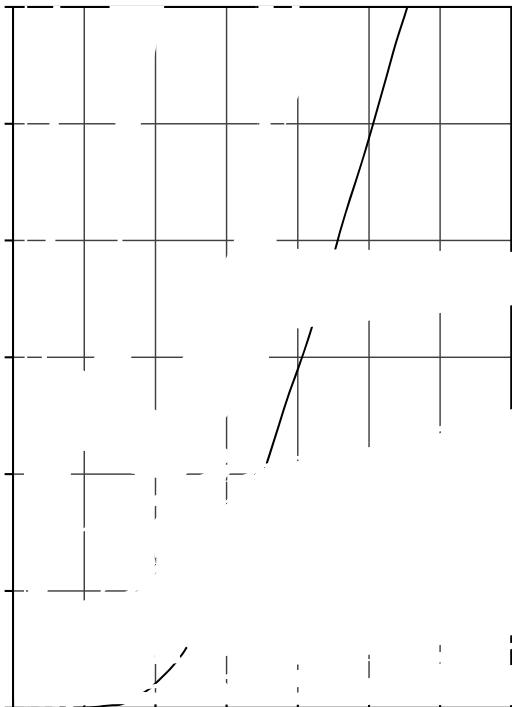
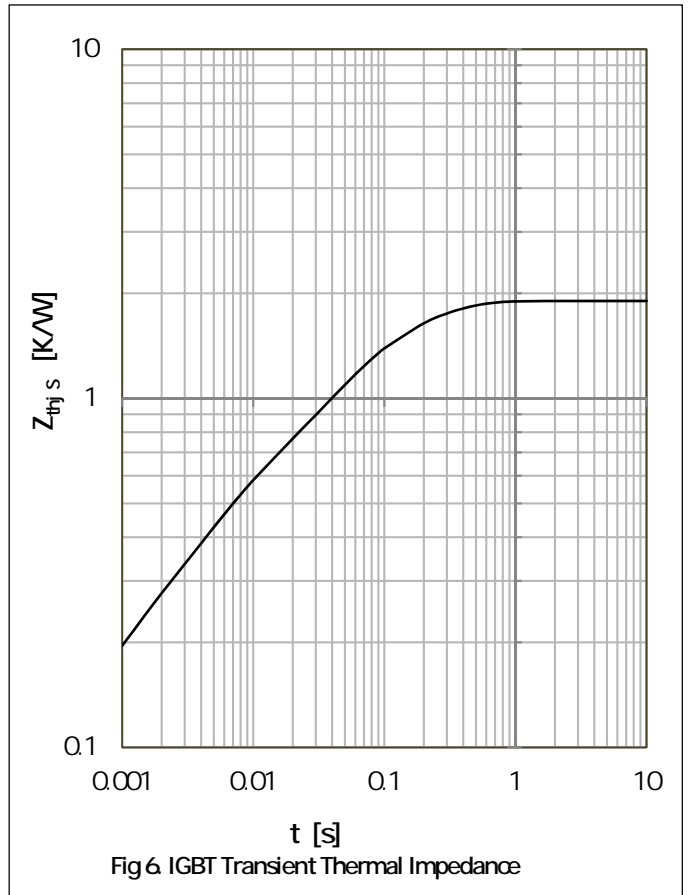
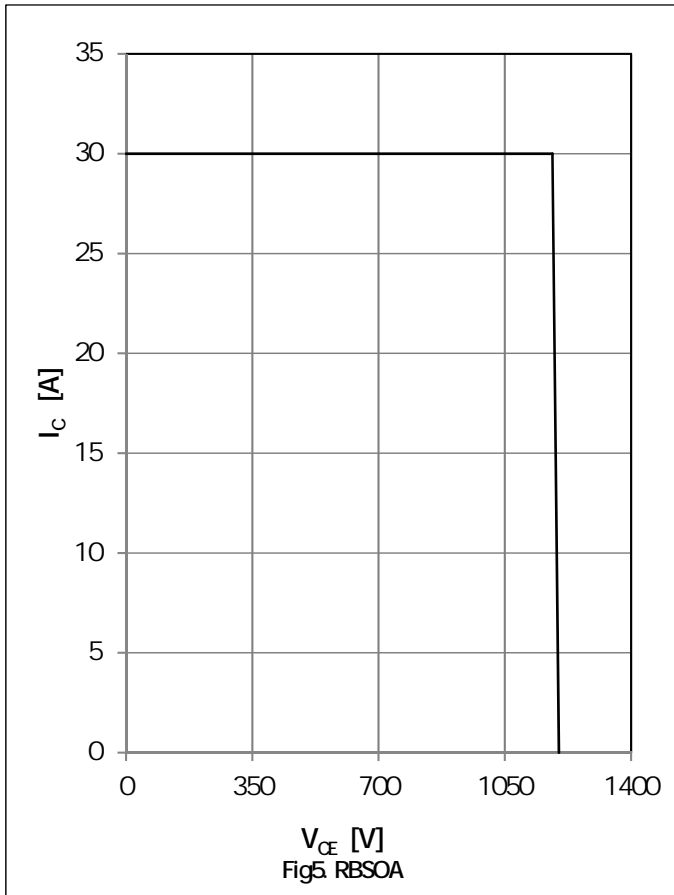



O I 37R34R4

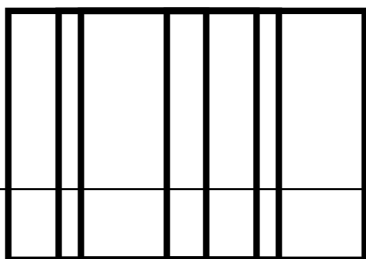
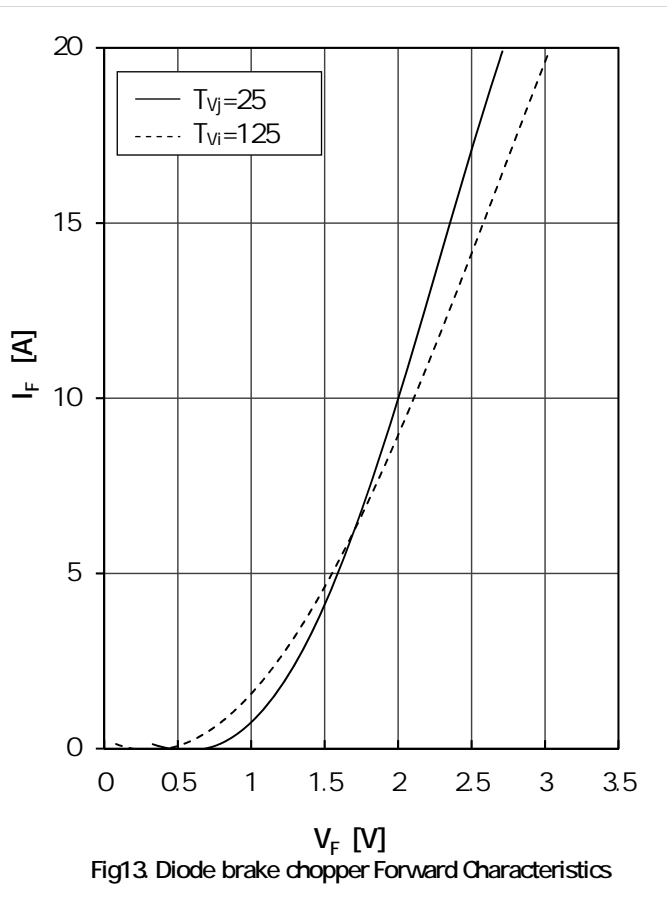



O I 37R34R4

RoHS
COMPLIANT

Circuit Diagram

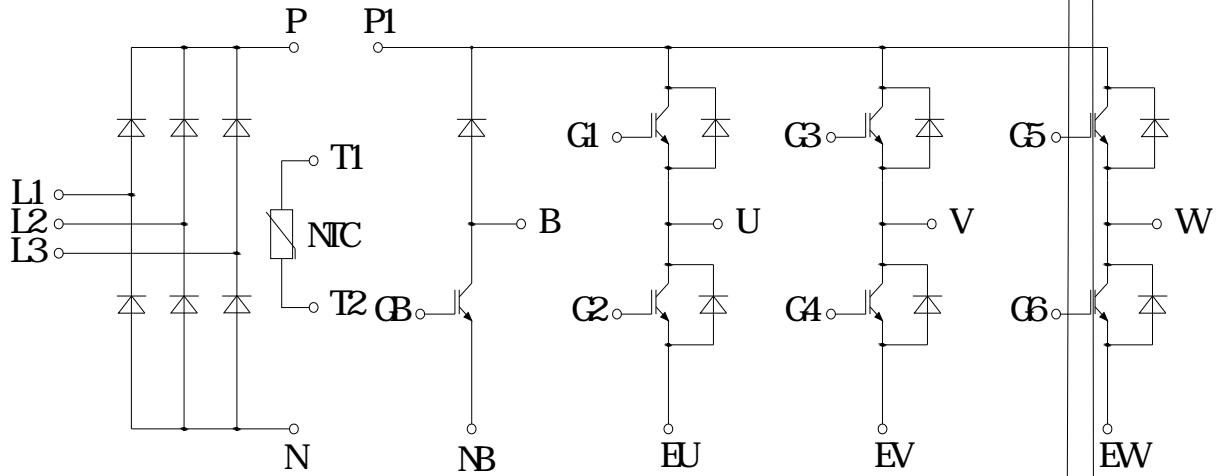

Package Dimensions

