

---



**Characteristic values**

Parameter	Symbol	Conditions	Value			Unit	
			Min.	Typ.	Max.		
Gate-emitter Threshold Voltage	$V_{GE(th)}$	$V_{GE}=V_{CE}, I_C=7.6mA, T_{vj}=25$	5.0	5.8	6.5	V	
Collector-Emitter Cut-off Current	$I_{CES}$	$V_{CE}=1200V, V_{GE}=0V, T_{vj}=25$			1.0	mA	
Collector-Emitter Saturation Voltage	$V_{CE(sat)}$	$I_C=200A, V_{GE}=15V, T_{vj}=25$		1.85	2.20	V	
		$I_C=200A, V_{GE}=15V, T_{vj}=125$		2.20			
		$I_C=200A, V_{GE}=15V, T_{vj}=150$		2.30			
Gate Charge	$Q_G$			1.2		uC	
Internal Gate Resistor	$R_{Gint}$			3.8			
Input Capacitance	$C_{ies}$	$V_{CE}=25V, V_{GE}=0V,$		12.8		nF	
Reverse Transfer Capacitance	$C_{res}$	$f=1MHz, T_{vj}=25$		0.5		nF	
Gate-Emitter leakage current	$I_{GES}$	$V_{CE}=0V, V_{GE}=20V, T_{vj}=25$			400	nA	
Turn-on Delay Time	$t_{d(on)}$	$I_C=200A$ $V_{CE}=600V$ $V_{GE}=\pm 15V$ $R_G=3.3\Omega$ $T_{vj}=25$		280		ns	
Rise Time	$t_r$			45		ns	
Turn-off Delay Time	$t_{d(off)}$			320		ns	
Fall Time	$t_f$			120		ns	
Energy Dissipation During Turn-on Time	$E_{on}$			15.8		mJ	
Energy Dissipation During Turn-off Time	$E_{off}$			16.4		mJ	
Turn-on Delay Time	$t_{d(on)}$			360		ns	
Rise Time	$t_r$			50		ns	
Turn-off Delay Time	$t_{d(off)}$			450		ns	
Fall Time	$t_f$			125		ns	
Energy Dissipation During Turn-on Time	$E_{on}$	$T_{vj}=125$		23.7		mJ	
Energy Dissipation During Turn-off Time	$E_{off}$			24.8		mJ	
Turn-on Delay Time	$t_{d(on)}$	$I_C=200A$ $V_{CE}=600V$ $V_{GE}=\pm 15V$ $R_G=3.3\Omega$ $T_{vj}=150$		393		ns	
Rise Time	$t_r$			53		ns	
Turn-off Delay Time	$t_{d(off)}$			483		ns	
Fall Time	$t_f$			132		ns	
Energy Dissipation During Turn-on Time	$E_{on}$			27.5		mJ	
Energy Dissipation During Turn-off Time	$E_{off}$			29.4		mJ	
SC Data	$I_{sc}$		$T_p \leq 10\mu s, V_{GE}=15V,$ $T_{vj}=150, V_{cc}=900V,$ $V_{CEM} \leq 1200V$		1000		A

**● Diode****Absolute Maximum Ratings**

Parameter	Symbol	Conditions	Value	Unit
Repetitive Peak Reverse Voltage	$V_{RRM}$	$T_{vj}=25$	1200	V
Continuous DC Forward Current	$I_F$		200	A
Repetitive Peak Forward Current	$I_{FRM}$	$t_p=1ms$	400	A
$I^2t$ -value	$I^2t$	$V_R=0, t_p=10ms, T_j=125$	7550	A <sup>2</sup> s
		$V_R=0, t_p=10ms, T_j=150$	7100	

**Characteristic values**

Parameter	Symbol	Conditions	Value			Unit
			Min.	Typ.	Max.	
Forward Voltage	$V_F$	$I_F=200A, T_{vj}=25$		2.00		V
		$I_F=200A, T_{vj}=125$		2.00		
		$I_F=200A, T_{vj}=150$		1.95		
Recovered Charge	$Q_{rr}$	$I_F=200A$		15.4		uC
Peak Reverse Recovery Current	$I_{rr}$	$V_R=600V$ $-di_F/dt=2500A/us$		150		A
Reverse Recovery Energy	$E_{rec}$	$T_{vj}=25$		8.8		mJ
Recovered Charge	$Q_{rr}$	$I_F=200A$		30.6		uC
Peak Reverse Recovery Current	$I_{rr}$	$V_R=600V$ $-di_F/dt=2500A/us$		180		A
Reverse Recovery Energy	$E_{rec}$	$T_{vj}=125$		14.8		mJ
Recovered Charge	$Q_{rr}$	$I_F=200A$		35.4		uC
Peak Reverse Recovery Current	$I_{rr}$	$V_R=600V$ $-di_F/dt=2500A/us$		197		A
Reverse Recovery Energy	$E_{rec}$	$T_{vj}=150$		16.2		mJ



● **Module Characteristics**

$T_c=25^{\circ}\text{C}$  unless otherwise specified

Parameter	Symbol	Conditions	Value			Unit
			Min.	Typ.	Max.	
Isolation voltage	$V_{\text{isol}}$	$t=1\text{min}, f=50\text{Hz}$	2500			V
Maximum Junction Temperature	$T_{\text{jmax}}$				175	
Operating Junction Temperature	$T_{\text{vj op}}$		-40		150	
Storage Temperature	$T_{\text{stg}}$		-40		125	
Thermal Resistance Junction-to Case	$R_{\text{JC}}$	per IGBT			0.12	K/W
		per Diode			0.20	
Thermal Resistance Case-to Sink	$R_{\text{CS}}$	Conductive grease applied		0.046		K/W
Comparative Tracking Index	CTI			>400		
Module Electrodes Torque	$M_t$	Recommended(M6)	3.0		5.0	N·m
Module-to-Sink Torque	$M_s$	Recommended(M6)	3.0		5.0	N·m
Weight of Module	G			315		g

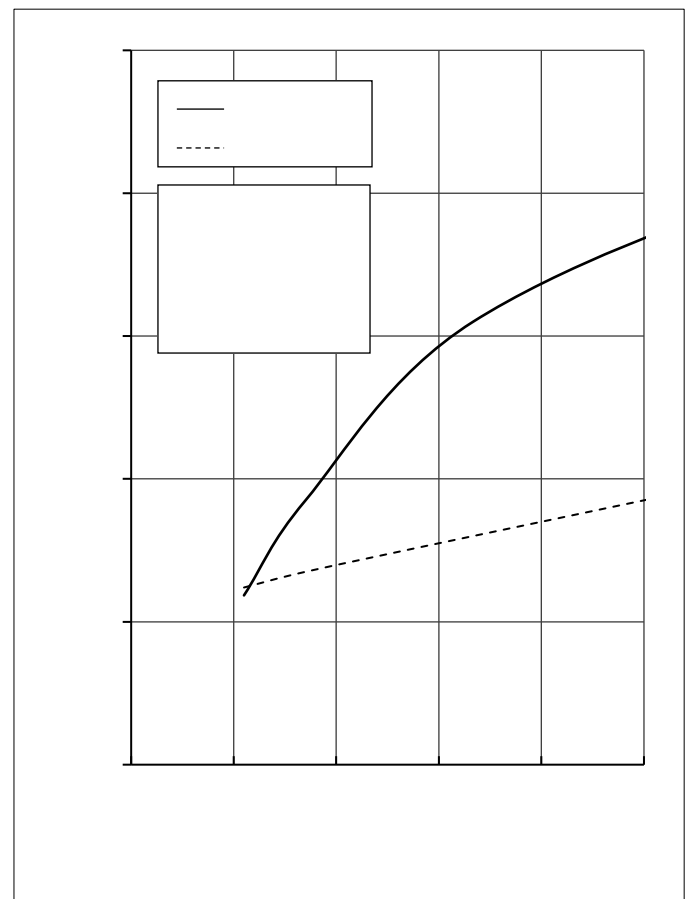
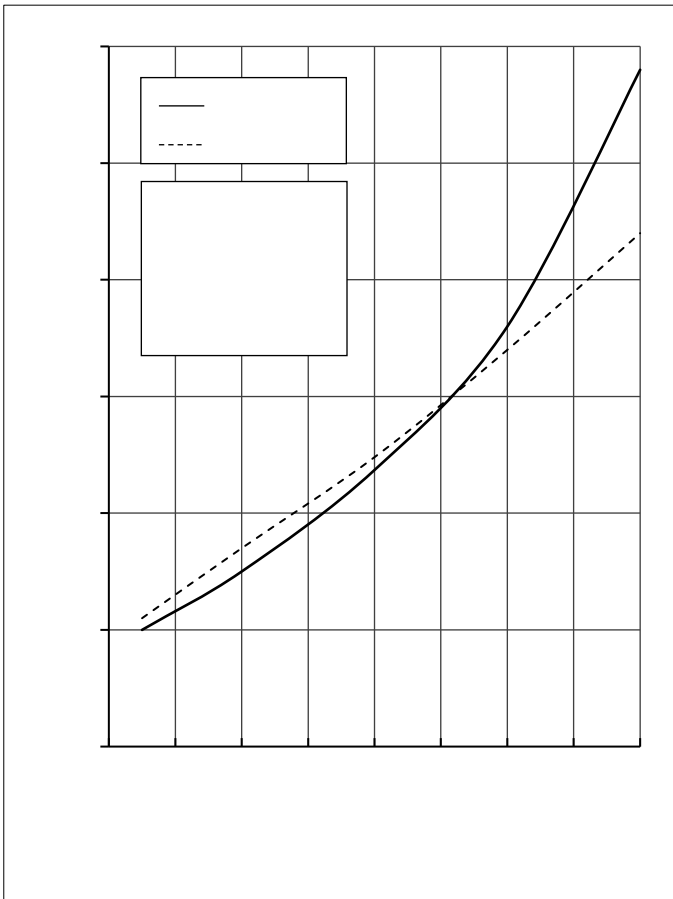
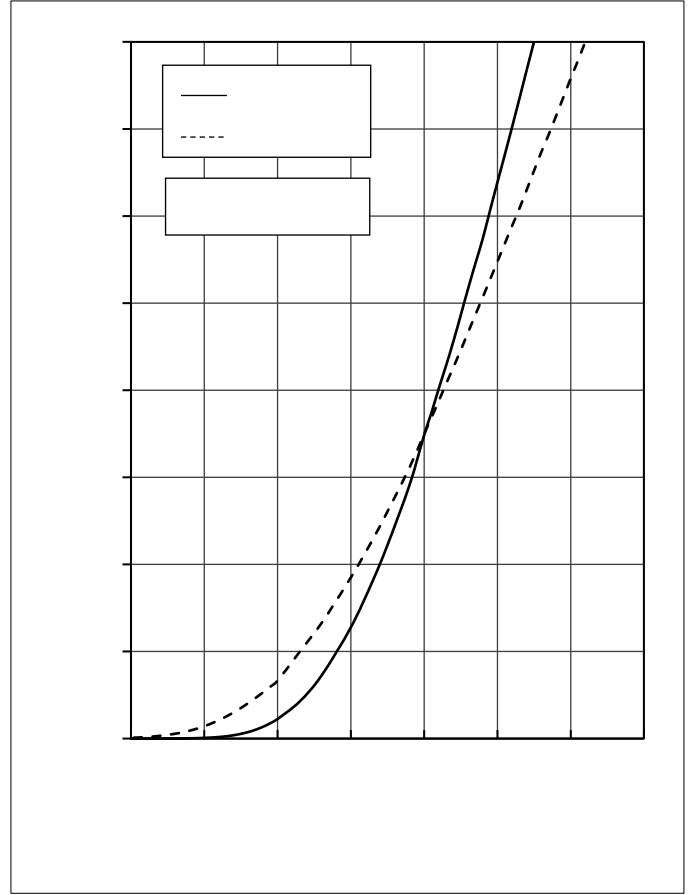
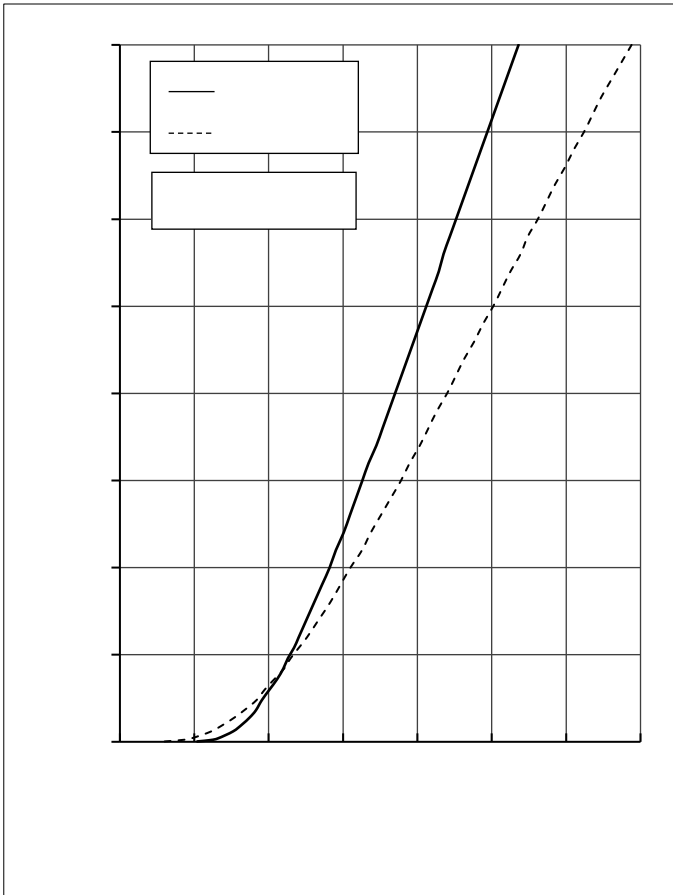

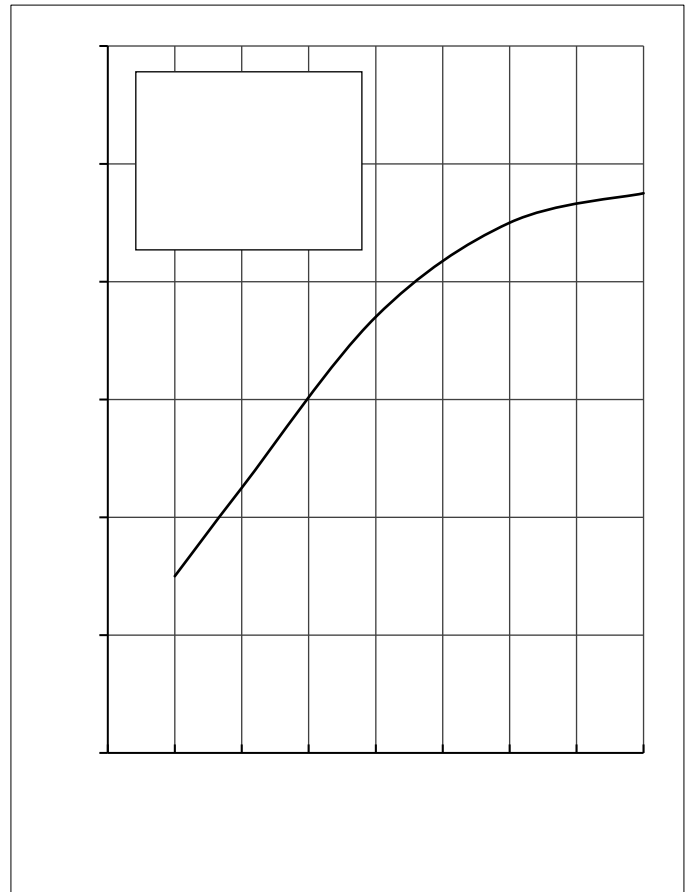
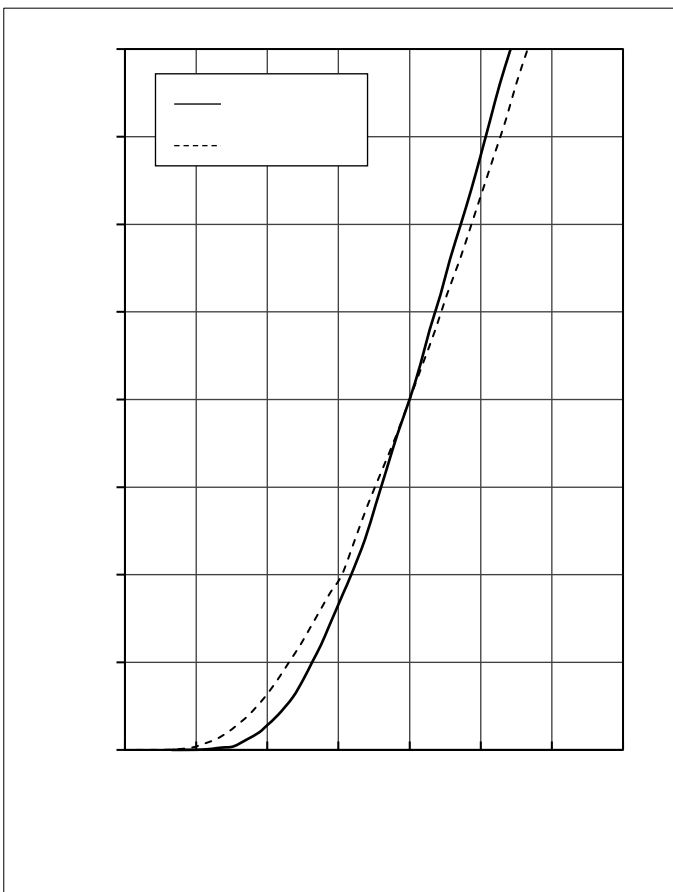
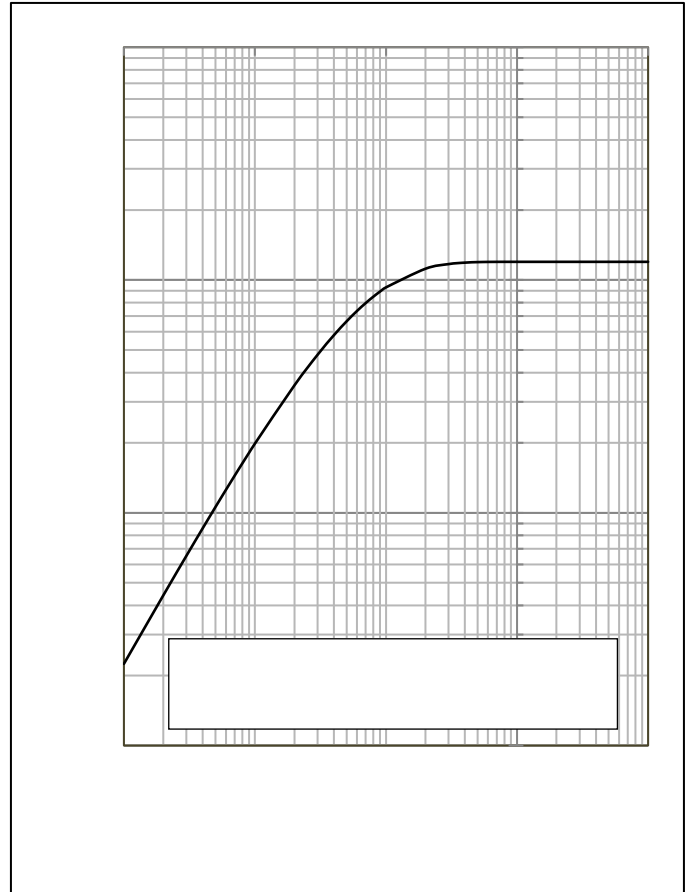
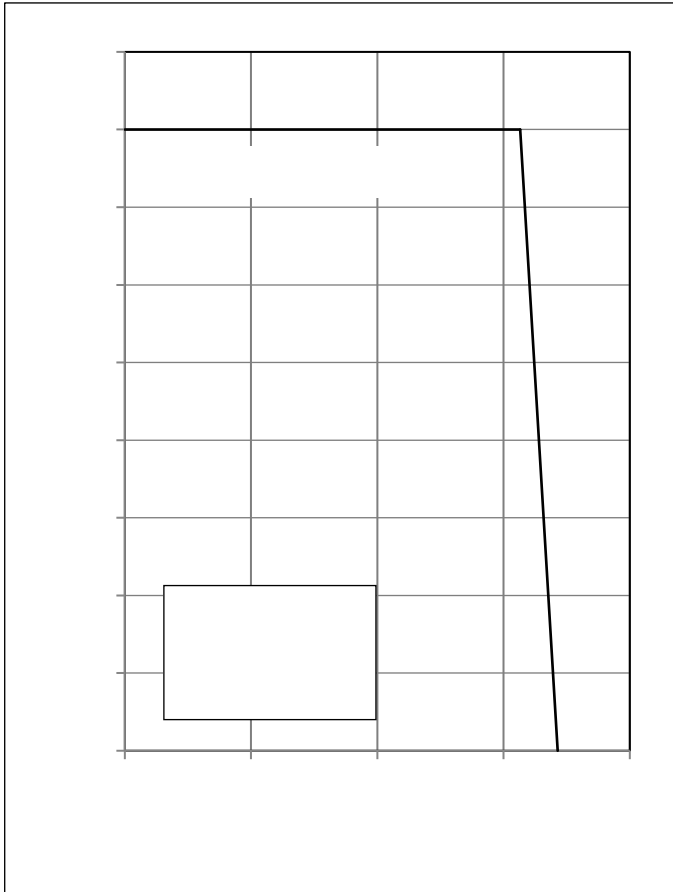

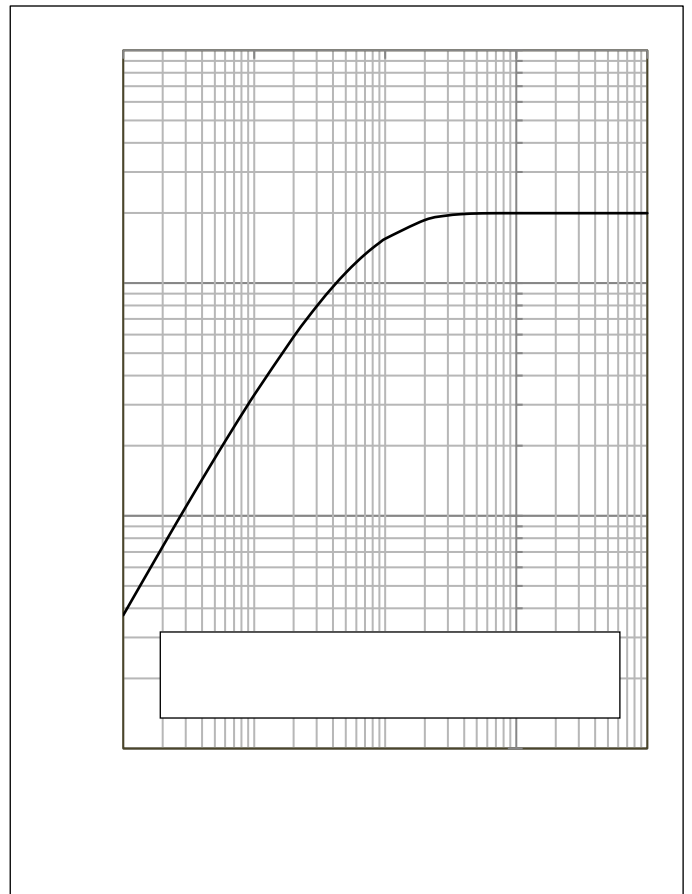
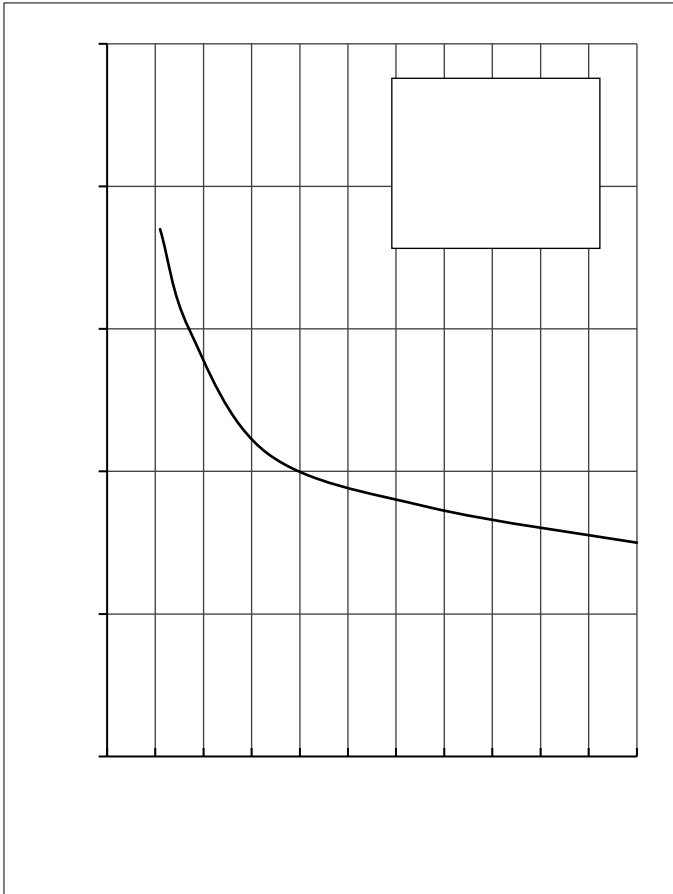

● **Circuit Diagram**

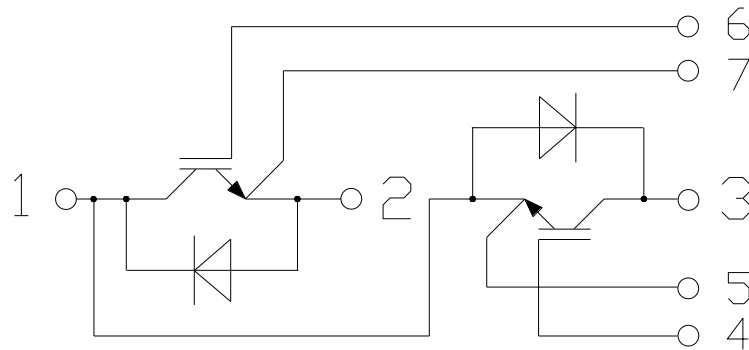

● **Package Outline Information**

Dimensions in Millimeters

