

规格承认书

—

prepare	
check	
approve	



TRX电容一级代理商
深圳市弗瑞鑫电子有限公司

Add: 深圳市宝安区西乡大道302号金源商务大厦B座3楼

Tel: 0755-29563634

Fax: 0755-27447020

- 2

2 . .

/

/

/

/

	- 2 2 . .		
	/		/
	/		/



TRX

专注电容器廿年

/

/

/

2

5

⑥

23

/	
	
	± ±

3. /

↓	↓				
		↓	↓		

4. /

5. /

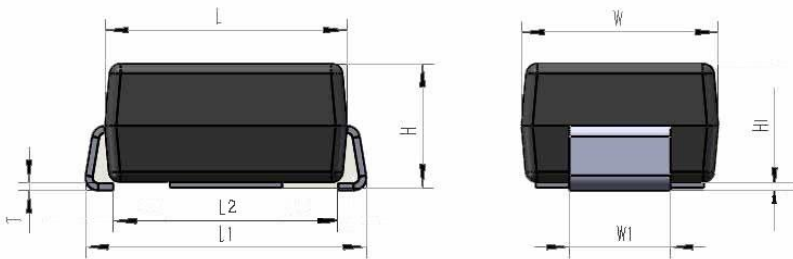

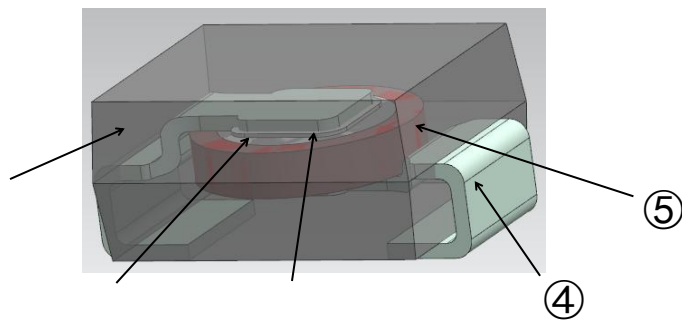

①		
②		
③		
④		
⑤		

- 2
2 . .

/

/

/

01

01

	- 2 2 . .		
	/		/
	/		/

/

°
°C

°

°

°

/

7. /

	- 2 2 . .		
	/		/
	/		/





- 2
2 ..

/

/

/

/

					±
		±			
		±			
		±			
		±			

			± ±
			± ±
			± ±

8. /

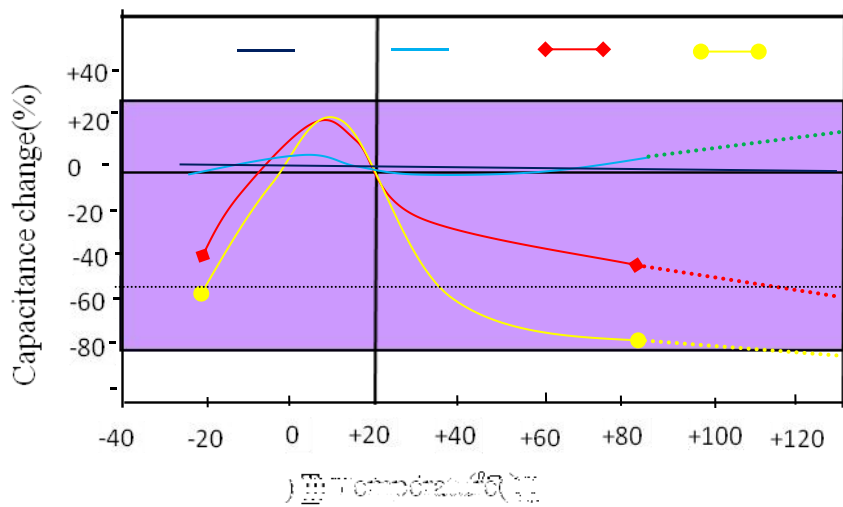

11. /
/

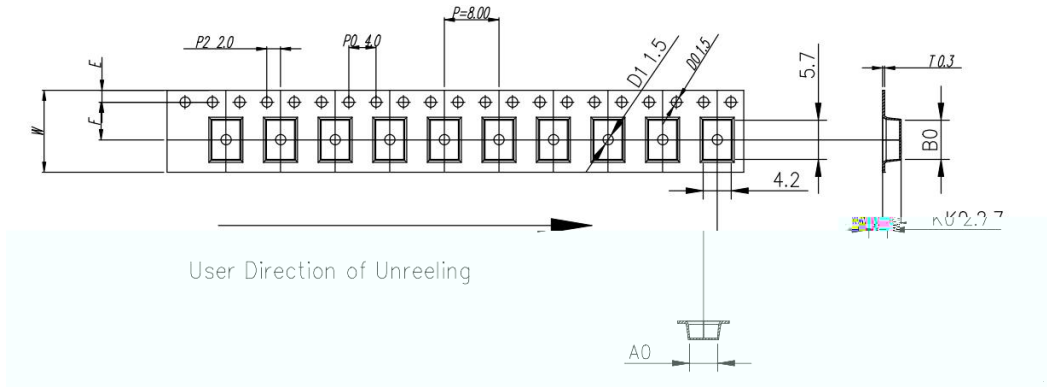

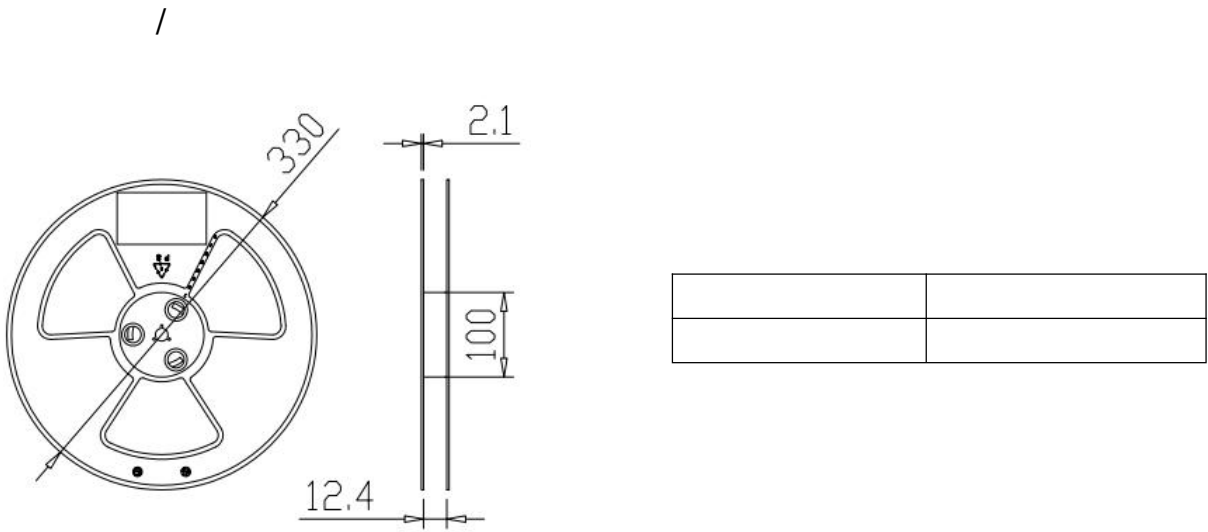

ITEM	W	A0	B0	K1	K0	P	F	E	D0	D1	P0	P2	T
DIM	12.0	$4.00^{+0.30/-0.30}$	$5.70^{+0.10/-0.10}$	--	$2.70^{+0.10/-0.10}$	$8.00^{+0.10/-0.10}$	$5.50^{+0.10/-0.10}$	$1.75^{+0.10/-0.10}$	$\phi 1.5^{+0.10/-0.00}$	$\phi 1.5^{+0.10/-0.10}$	$4.00^{+0.10/-0.10}$	$2.00^{+0.10/-0.10}$	$0.30^{+0.05/-0.05}$
ALTERNATE													



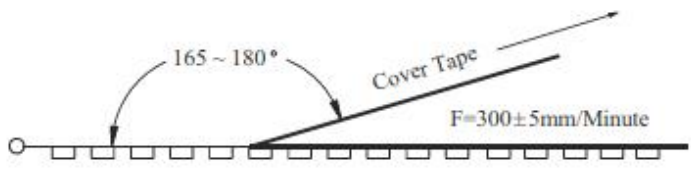

/

Item	Data	Remark
Cover tape adhesion	10 ~ 100g	Carrier tape and cover tape open angle 165 ~ 180° F=300±5mm/minute

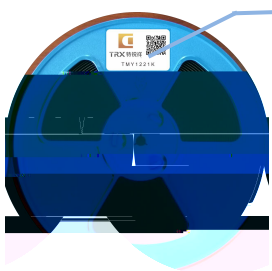

 TRX 专注电容器廿年	- 2 2 . .			
	/		/	
	/		/	

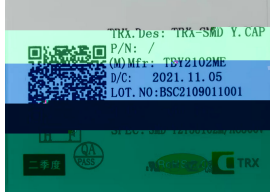
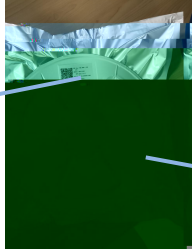
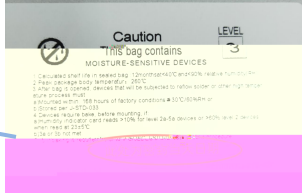
/ -	 <p>标签</p>	 <p>料号</p>		
				

/ -				
	图示 /		图示 /	图示 /

/ :				
	/	/		

" "

	- 2 2 . .		
	/		/
	/		/

12. /

①

②