

---

---

---

一级代理商：

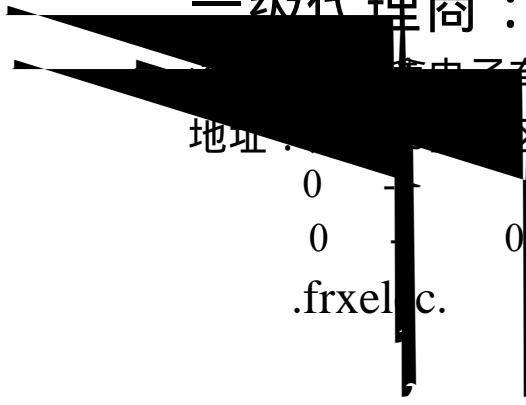

电子有限公司

地址：西乡大道302号金源商务大厦B座三楼

0  
0 0 0  
.frxel c.

## Features



## Description

### 3. Application Range

### 4. Functional Diagram

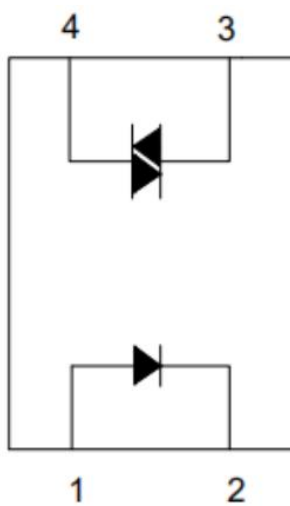

- 1. Anode
- 2. Cathode
- 3. Main terminal
- 4. Main terminal

5. Absolute Maximum Ratings (Ta=25 °C)

Parameter		Symbol	Rated Value	Unit	



**6. Electrical Optical Characteristics at Ta=25 C**

Parameter		S mbol	Min	T p.*	Ma	Unit	Condition



## 7. Order Information

Part Number

**OR-M302X(L)-W-Y-Z**

**OR-M305X(L)-W-Y-Z**

Or **OR-M307X(L)-W-Y-Z**

Note

Option	Description	Packing quantity

## 8. Naming Rule

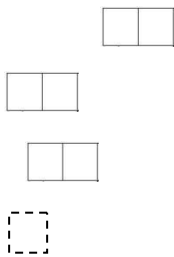
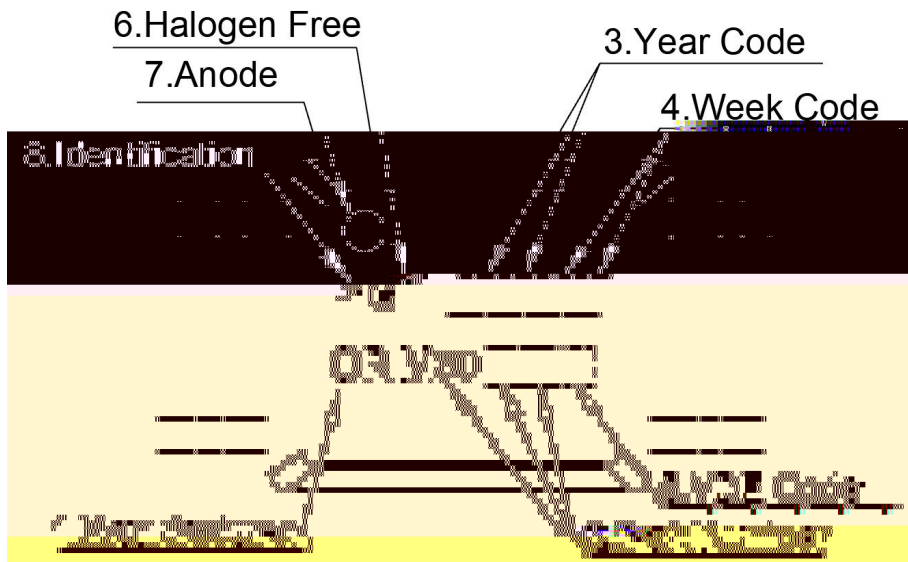

### 9. Package Dimension

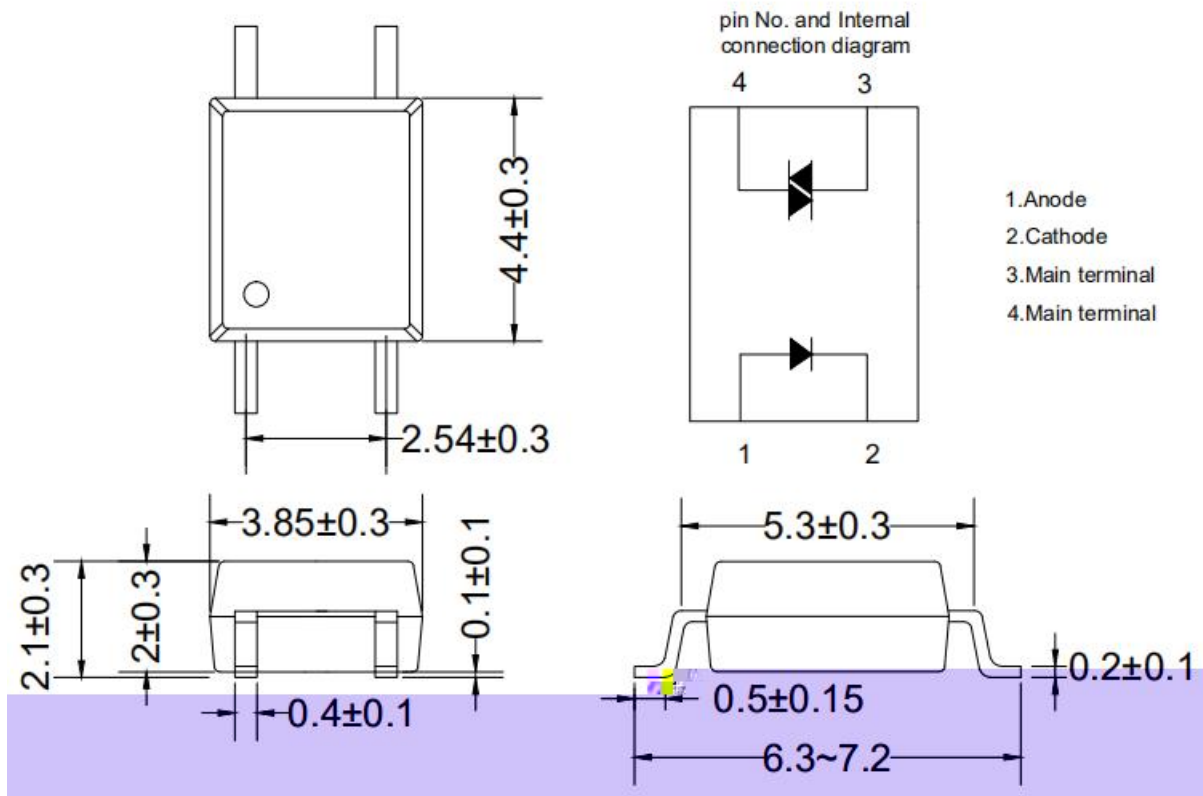

### 10. Recommended Foot Print Patterns (Mount Pad)

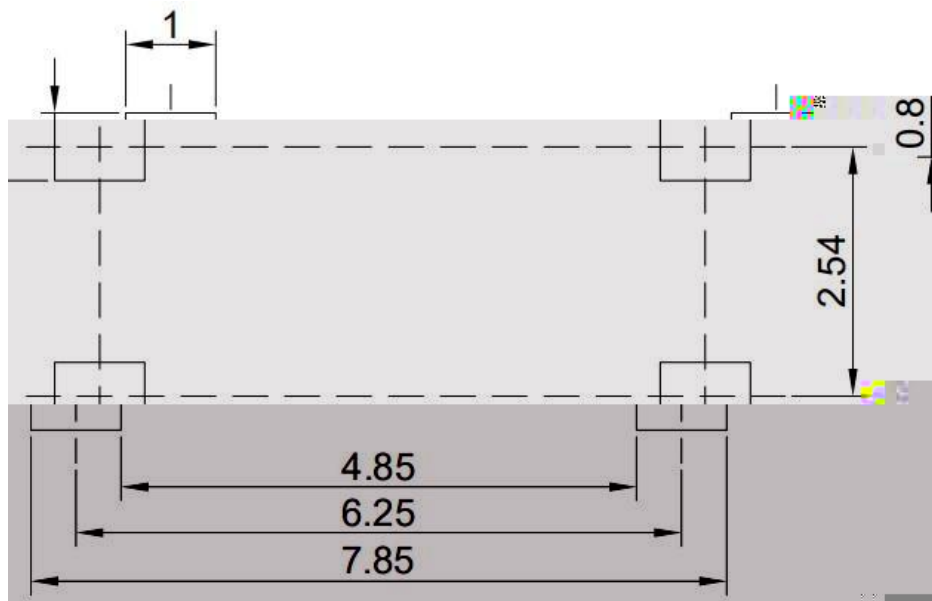

nit mm

### 11. Taping Dimensions

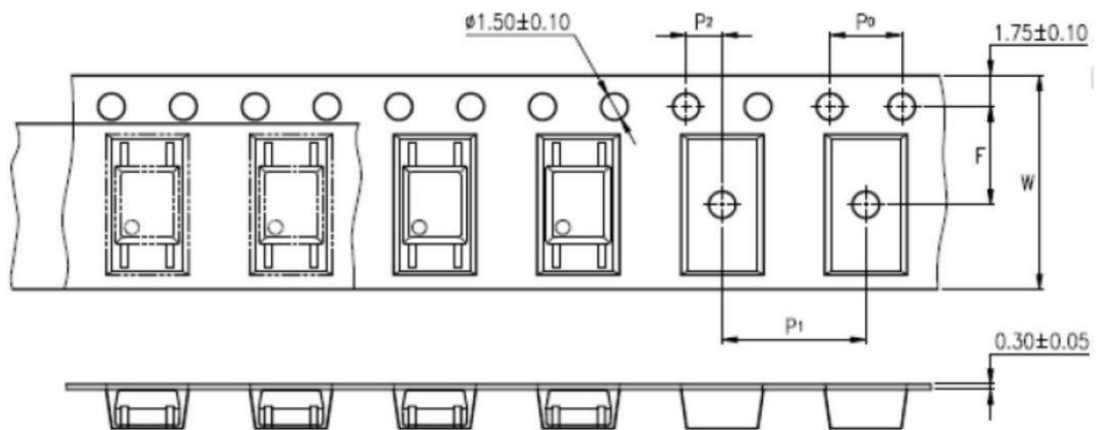
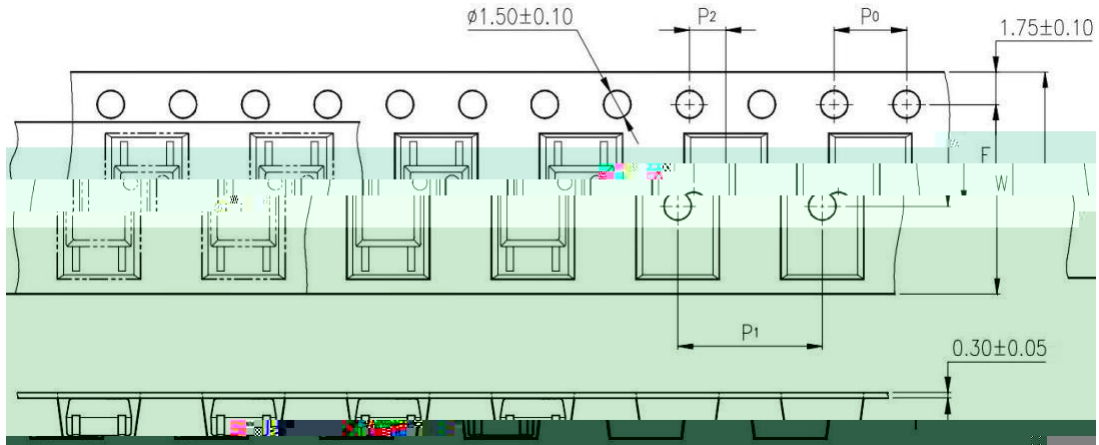





## 12. Package Dimension

Packing Information	



### Note





--	--

## 14. CHARACTERISTICS CURVES (TYPICAL PERFORMANCE)

Fig.1 Forward current vs Ambient temperature

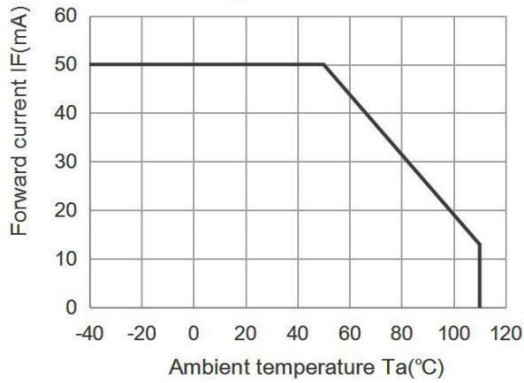

Fig.2 On-state current vs. Ambient temperature

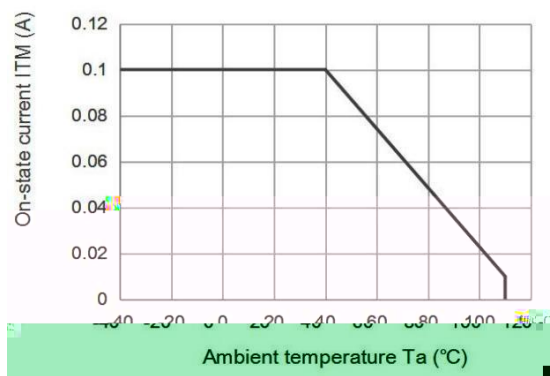

Fig.3 Minimum Trigger Current vs. Ambient temperature

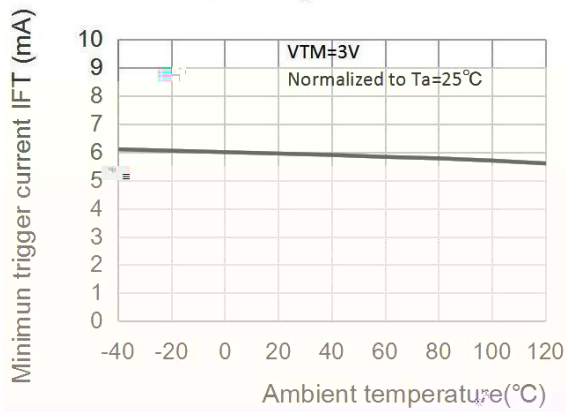

Fig.4 Forward current vs. Forward voltage

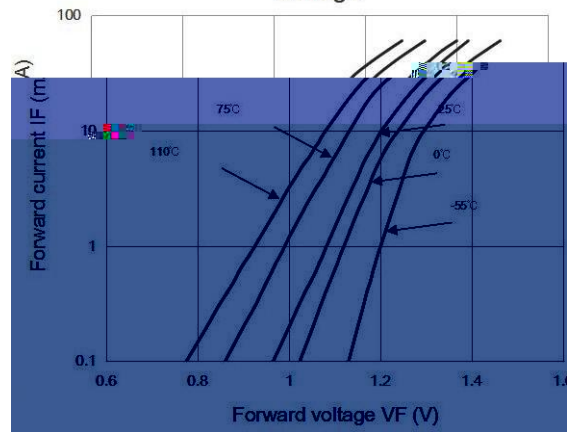

Fig.5 On-state voltage vs. Ambient temperature

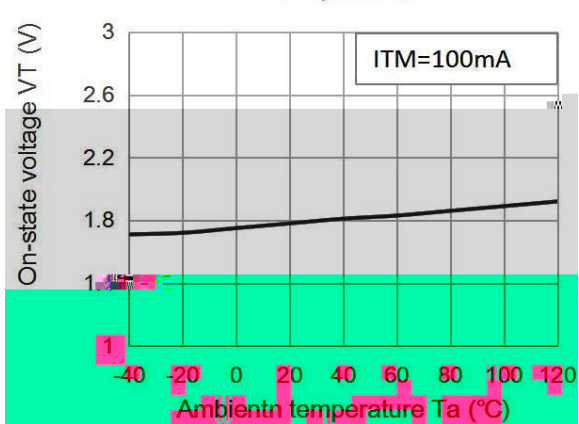

Fig.6 Holding current vs. Ambient temperature

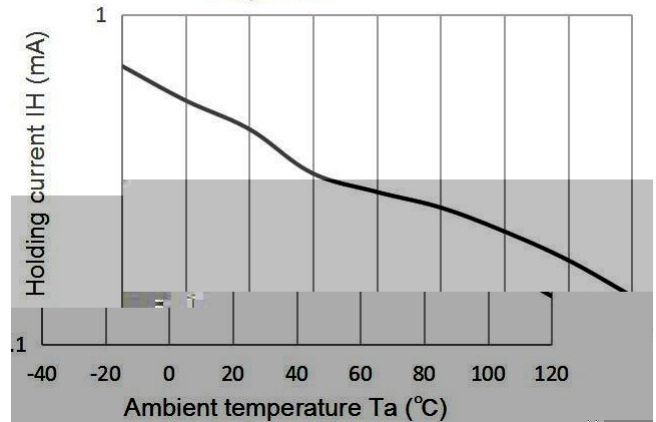

Fig.7 Repetitive peak off-state current vs. Temperature

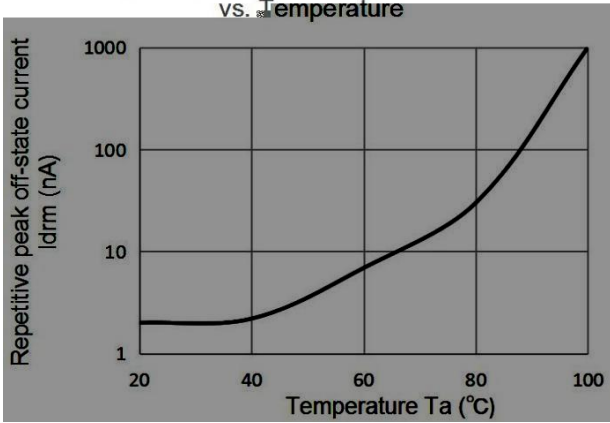
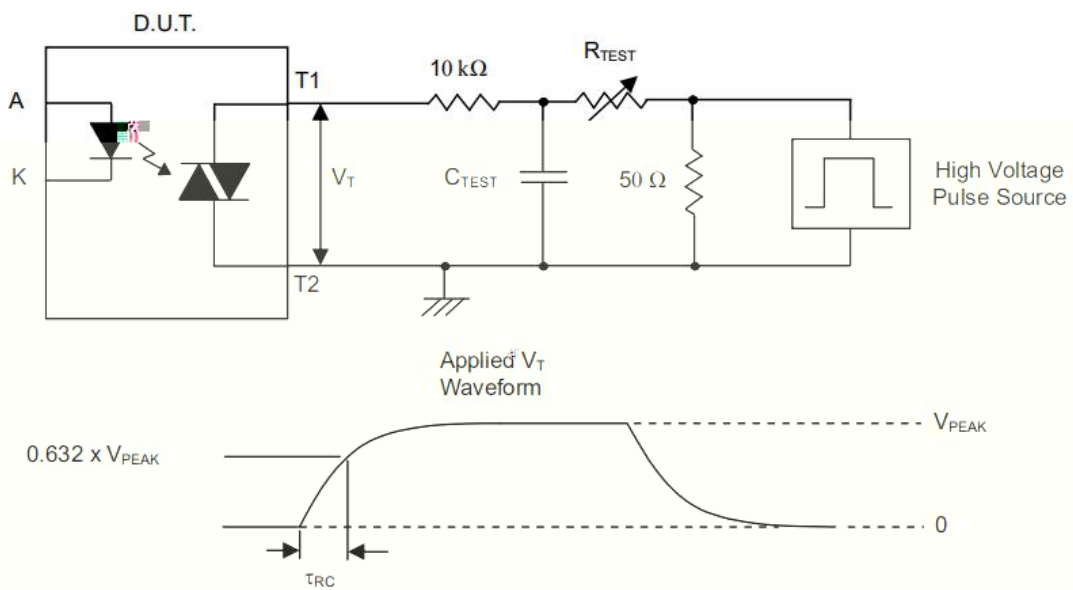
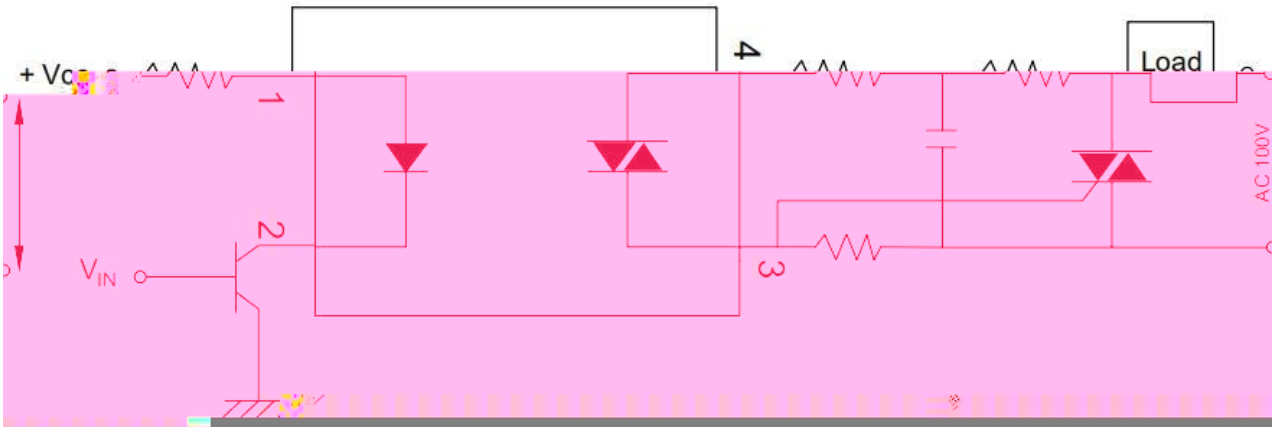
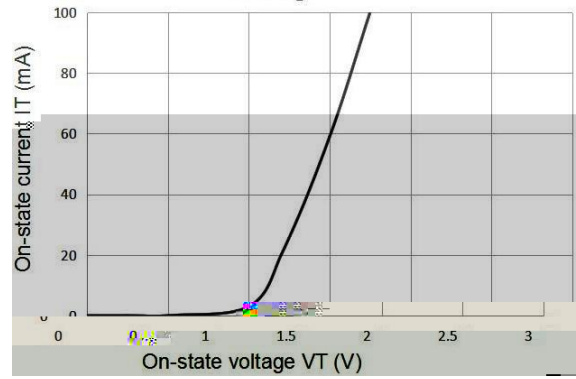

Fig.8 On-state current vs. On-state voltage



## Measurement Method

The high voltage pulse is set to the required  $V_{PEAK}$  value and applied to the D.U.T. output side through the RC circuit above. LED current is not applied. The waveform  $V_T$  is monitored using a x100 scope probe. By varying  $R_{TRES}$

$$\frac{dv/dt}{V_{PEAK}} = \frac{0.0037 \times V_{PEAK}}{100}$$

$$\frac{dv/dt}{V_{PEAK}} = \frac{0.0028 \times V_{PEAK}}{100}$$

For example  $V_{PEAK} = 300V$  and  $R_{TRES} = 100\Omega$ . The  $\frac{dv/dt}{V_{PEAK}}$  values are as follows:

$$\frac{dv/dt}{V_{PEAK}} = \frac{0.0037 \times 300}{100} = 0.0111$$