



MG25P12E1A □

D
/

-]tj 2 V6Sa
- / 1 OR21 aSd] R V6SQ V6V
- C A C V6S c bPVS]eS Ac V6a

-]e ae V6WU]aaSa
-]e dcaob e V6]a V6S tS] S Qc S Q STTOS b
- 7 QcRWU Tcab a] T S Q dS g O bWOOS E 2
-]e WRc QO QS QaS
- 6 V6Va] bQVc V6Q CPV6] ca
- Of V6c] c QV tS] S Qc S °C

1] SQ] 3[V6S D] tOUS	D _{13A}	D ₃₊ D $\bar{\eta}$ + [/ B _{d+} °C		D
1] bWc] ca1] SQ] 1c S b	$\bar{\eta}$	B _{d+} °C, T _{d[α]= °C}		/
S S V6S SO 1] SQ] 1c S b	$\bar{\eta}$	b + [a		/
Q6S 3[V6S D] tOUS	D _{3A}	B _{d+} °C	\pm	D

B]tO]eS 2 V6Wc]V

B_{d+} °C
B_{d[α +}



MG25P12E1A

CS S[VS BV SaV] RD] tOUS	D _{3W}	D ₃ +D ₁₃ $\bar{7} +$ [/ B _d + °C			& D	
1] SQ] 3[VS 1 cb] T1 c S b	$\bar{7}$ _{3A}	D ₁₃ + DD ₃ + D B _d + °C			[/	
1] SQ] 3[VS ACc Cb]V D] tOUS	D _{13 aCb}	$\bar{7}$ ₊ / D ₃ + D B _d + °C		&	D	
		$\bar{7}$ ₊ / D ₃ + D B _d + °C				
		$\bar{7}$ ₊ / D ₃ + D B _d + °C				
CS1 VOUS					c1	
7 cb1 O CQO CS	1 _{Wa}	D ₁₃ + D D ₃ + D				
SdS aSB O aTS 1 O CQO CS	1 _{Sa}	$\bar{7}$ ₊ 6h B _d + °C				
CS 3[VS SO CUS Cc S b	$\bar{7}$ _{3A}	D ₁₃ + D D ₃ + D B _d + °C			/	
Bc] 2SQg B \bar{V} S	b _{R]}	$\bar{7} +$ / D ₁₃ + D D ₃ + D + & B _d + °C		&	a	
VS B \bar{V} S	b				a	
Bc] T2SQg B \bar{V} S	b _{R]T}				a	
O B \bar{V} S	b _r			&	a	
3 S Ug 2 VS W Cb]V 2c WU Bc] B \bar{V} S	3 _j			&	[8	
3 S Ug 2 VS W Cb]V 2c WU Bc] TTB \bar{V} S	3 _{jT}				[8	
Bc] 2SQg B \bar{V} S	b _{R]}				a	
VS B \bar{V} S	b				a	
Bc] T2SQg B \bar{V} S	b _{R]T}				a	
O B \bar{V} S	b _r				a	
3 S Ug 2 VS W Cb]V 2c WU Bc] B \bar{V} S	3 _j				[8	
3 S Ug 2 VS W Cb]V 2c WU Bc] TTB \bar{V} S	3 _{jT}			&	[8	
A1 2C0	$\bar{7}$ _Q		B caD ₃ + DB _d + °C D _{ca} + DD ₁₃ D			/



MG25P12E1A



S S WMS SO SdS aSD] tOUS	D	B _d + °C		D
1] bWc] ca 21] eOR1c S b	7			/
S S WMS SO] eOR1c S b	7	b+ [a		/
7bdOcS	7b	D + b+ [aB _d + °C		/ a
		D + b+ [aB _d + °C		

] eORD] tOUS	D	7+ / B _d + °C			D
		7+ / B _d + °C			
		7+ / B _d + °C			
SQ dS SR1 VOUS SO SdS aS SQ dS g		7+ / D + D RW _R + & / ca B _d + °C			c1



MG25P12E1A □

1] SQ] 3[WS D] tOUS	D _{13A}	$D_{3+} D_{\bar{1}} + [/ B_{d+} \text{ } ^\circ\text{C}$		D
1] bWc] ca1] SQ] 1c S b	$\bar{1}$	$B_{d+} \text{ } ^\circ\text{C}, T_{d[\alpha= \text{ } ^\circ\text{C}$		/
S WS SO 1] SQ] 1c S b	$\bar{1}$	$b + [a$		/
CS 3[WS D] tOUS	D _{3A}	$B_{d+} \text{ } ^\circ\text{C}$	\pm	D
B] tO] eS 2 W Wc]V	$\bar{1}b$	$B_{d+} \text{ } ^\circ\text{C} B_{d[\alpha+ \text{ } ^\circ\text{C}$		E

CS S[WS BV SaV] RD] tOUS	D _{3BV}	$D_{3+} D_{13} \bar{1} + [/ B_{d+} \text{ } ^\circ\text{C}$			& D
1] SQ] 3[WS 1cb] T1c S b	$\bar{1}_{3A}$	$D_{13+} DD_{3+} D B_{d+} \text{ } ^\circ\text{C}$			[/
1] SQ] 3[WS AOC Cb]V D] tOUS	D _{13 aOb}	$\bar{1} / D_{3+} D B_{d+} \text{ } ^\circ\text{C}$		&	D
		$\bar{1} / D_{3+} D B_{d+} \text{ } ^\circ\text{C}$			
		$\bar{1} / D_{3+} D B_{d+} \text{ } ^\circ\text{C}$			
CS 1 VOUS					c1
7 cb1 O CO CS	1 Wa	$D_{13+} D D_{3+} D$			
SdS aSB O aTS 1 O CO CS	1 Sa	$\bar{1} 6h B_{d+} \text{ } ^\circ\text{C}$		&	
CS 3[WS SO CUS Cc S b	$\bar{1}_{3A}$	$D_{13+} D D_{3+} D B_{d+} \text{ } ^\circ\text{C}$			/
Bc] 2SQg B]VS	$\bar{1}r]$	$\bar{1} + /$ $D_{13+} D$ $D_{3+} D$ $+ B_{d+} \text{ } ^\circ\text{C}$			a
WS B]VS	b				a
Bc] T2SQg B]VS	$\bar{1}r] \bar{1}$			&	a
O B]VS	$\bar{1}r$			&	a
3 S Ug 2 W Wc]V 2c WU Bc] B]VS	3]				
3 S Ug 2 W Wc]V 2c WU Bc] TTB]VS	3] $\bar{1}$				[8



MG25P12E1A

Bc] 2SQgBWS

br]

a

7 + /
D₁₃ + D
D₃ + D
+
B_d + °C



MG25P12E1A

S S MS SO SdSaSD] tOUS	D	B+ °C		D
/ dS OUS] cb cb1 c S b 6h aWSeQdS	7 /D	Bq+ °C		/
Cf Wc] A 1c S b Qb SOMV = cb cb	7 A	Bq+ °C		/
Ac US] eOR1c S b	7A	D + b+ [aB+ °C		/
7bdOcS	7b	D + b+ [aB+ °C		/ a

2 WRS] eORD] tOUS	D	7+ / B+ °C			D
SdSaS1c S b	7	B+ °C D + D			[/

OBR SaWKO GS					Ω
2SdWV] T		B ₁ + + Ω			
]eS 2WVWb]V					[E
0 dOcS	0	+ Sf 10 B & 9 K			9



MG25P12E1A

z] Cb]V d] tOUS	D _{Wj}	b+ [WFr 6h			D
Cf Wc[8c Q]V BS[S Ccc S	B[α				°C
= S CbWU 8c Q]V BS[S Ccc S	B _{d]}				°C
Atj CUSBS[S Ccc S	B _{atU}				°C
AbCg WRcQO QS [] Rc S	A13				nH
] Rc S SCR SaWtO QS tS [W0a QW	Ω 33 // 11	B ₁₊ °C S ae WQV			m Ω
BVS [O SaWtO QS 8c Q]V tj 1 CaS	081	S 7 0B WdS tS			9 E
		S 2 VRS WdS tS			
		S 7 0B POSQ S			
		S 2 VRS Q] S			
		S 2 VRS SQMS			
BVS [O SaWtO QS 1 CaS tj AW	01A	S 7 0B WdS tS			9 E
		S 2 VRS WdS tS			
		S 7 0B POSQ S			
		S 2 VRS Q] S			
		S 2 VRS SQMS			
		S] Rc S			
] c bWU] QS S 1 Q					
E SWb]T] Rc S				&	U

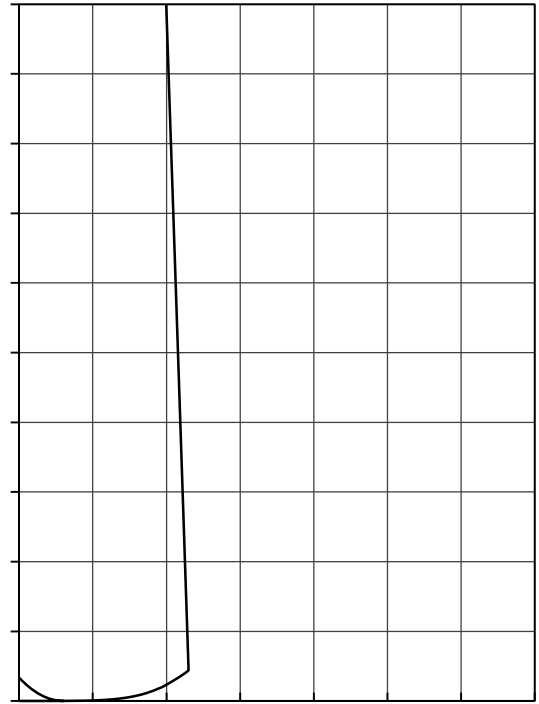
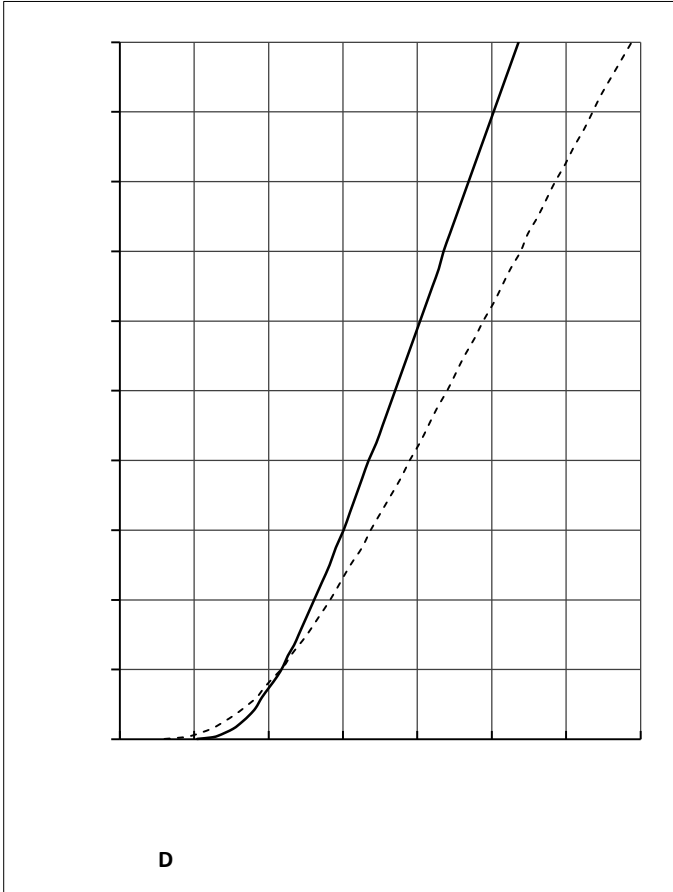

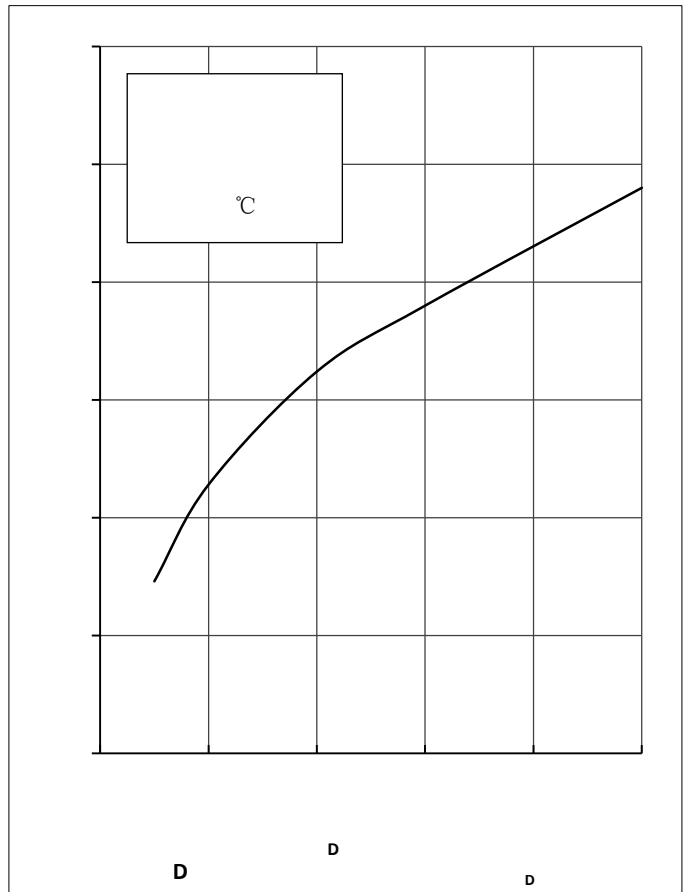
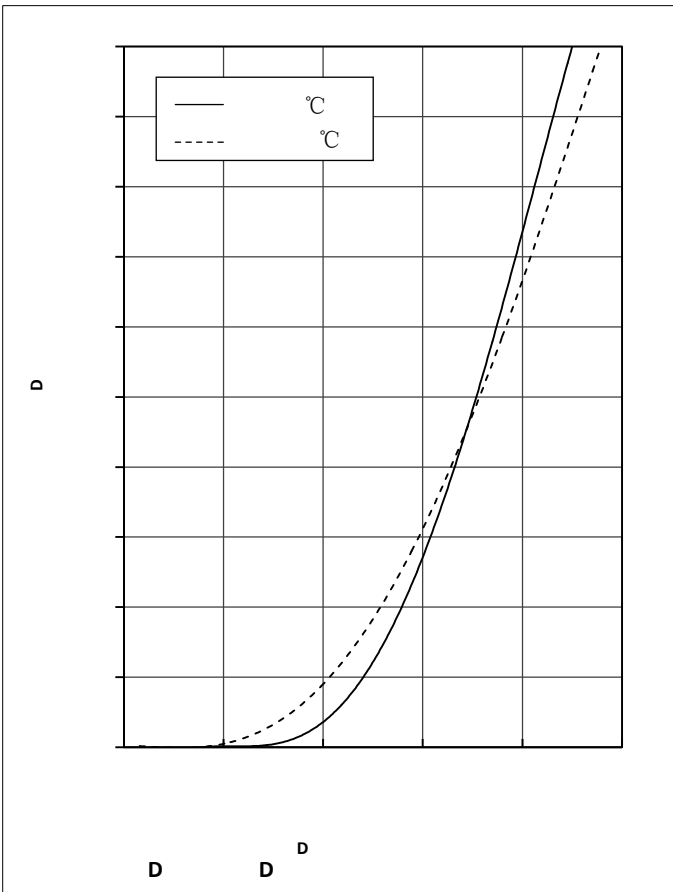
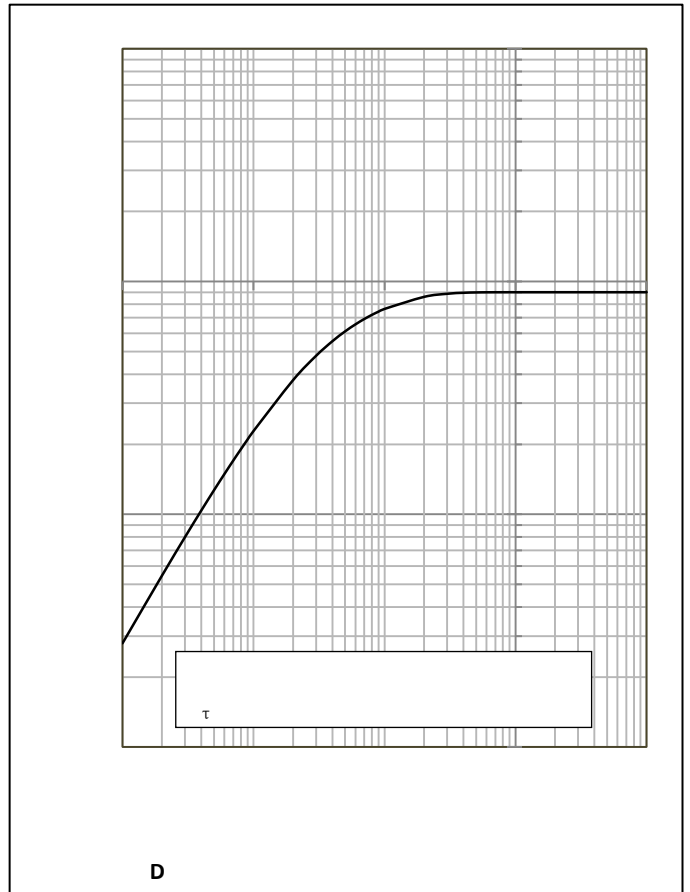
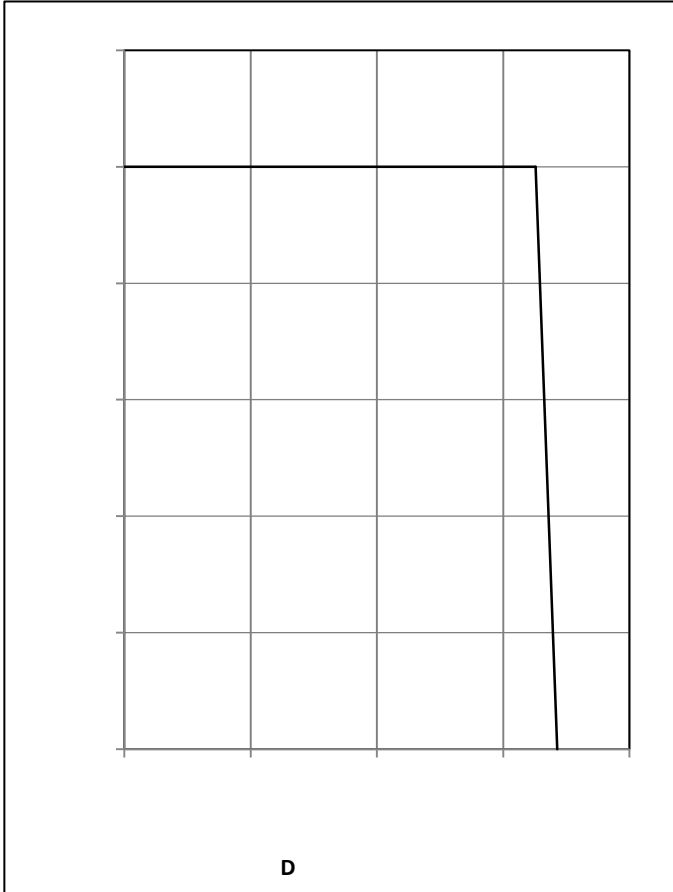

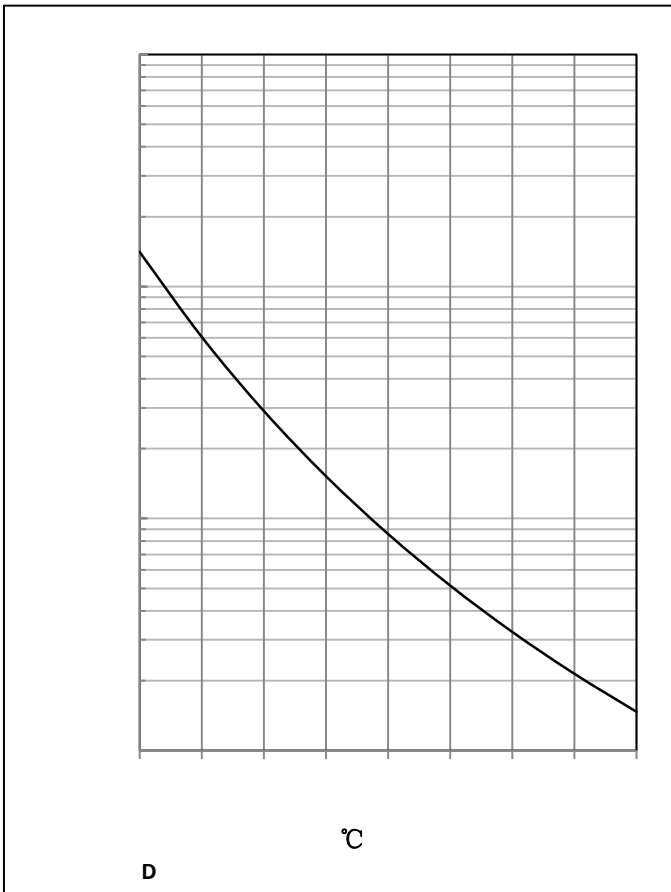
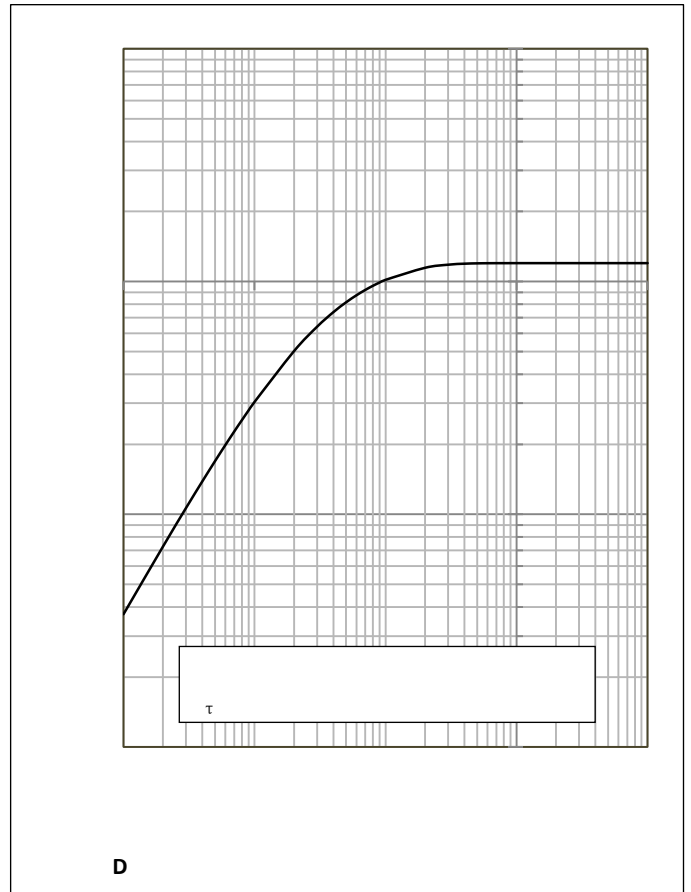
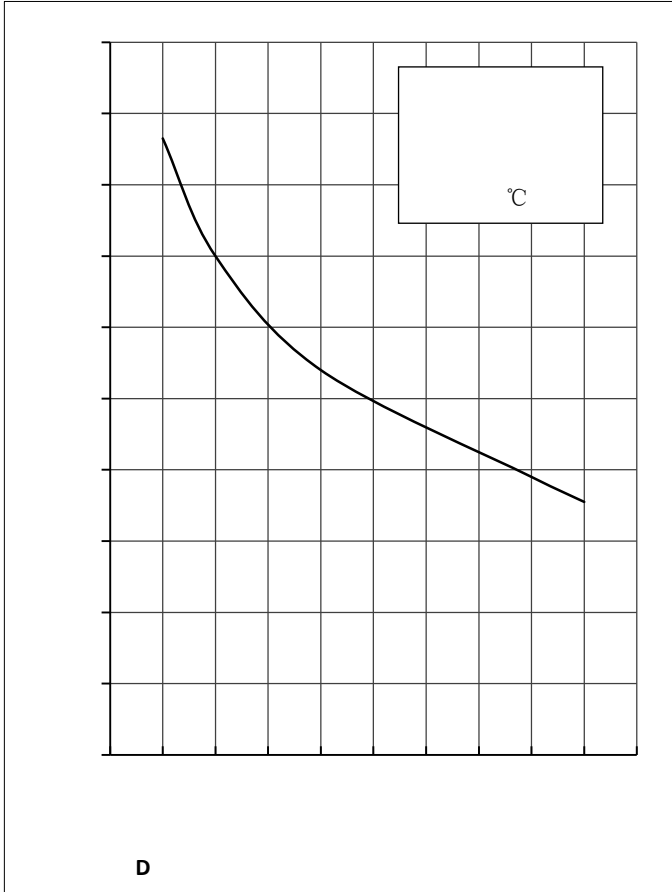



MG25P12E1A

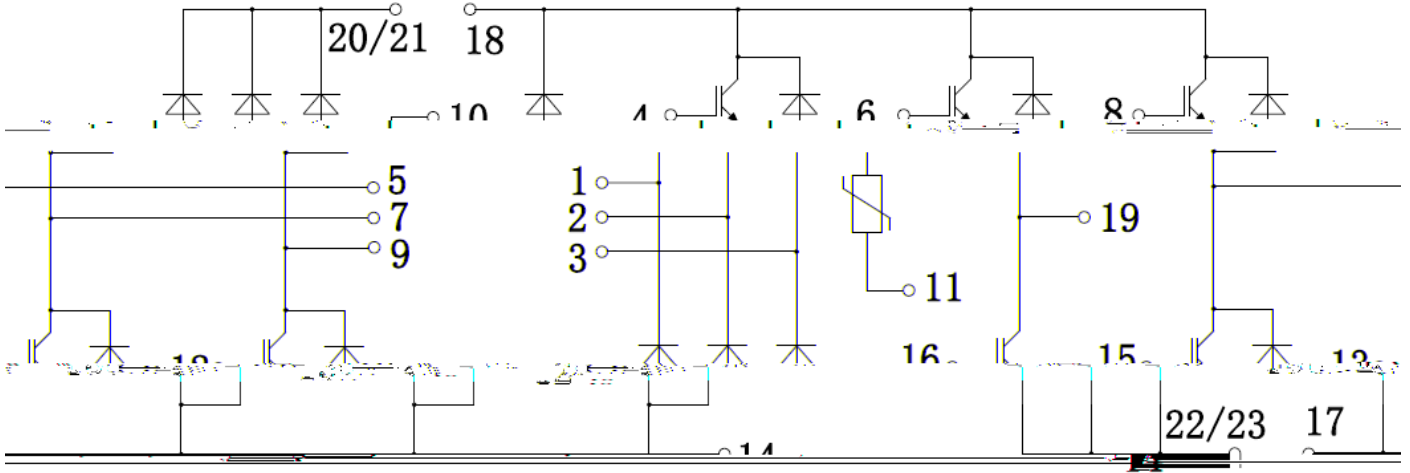

● Package Outline Information

