



规格承认书

/C OME _____

/ E IE PE L

/DE C IP ION _____

/ P.N. _____

P	OH	EACH	H
	OH	EACH	

/	/ ()
/	(,)
/	
/	
/	
/	



TRX 特锐祥
 专注电容器材料

TRX 电容器一级代理商

深圳市弗瑞鑫电子有限公司

Add : 深圳市宝安区西乡大道302号华丰金源商务大厦B座3楼

Tel : 0755-29563634

Emial : sales@frxelec.com

 TRX 专注电容器廿年	SMD Y2 a.c. ceramic capacitors			
	/Number	-0 2	/Date	2020-02-10
	/Edition	0	/Page	2

/E.C.LIST

	- 2.				
			0		2020-02-10
0	2020-02-10				
			/		

1	/	2 1	- 2	1 /	00	0
2	/	2102	- 2	102 /	00	0
	/	2222	- 2	222 /	00	0
	/	2	- 2	2 /	00	0
	/	2	- 2	2 /	00	0
10						
11						
12						

2/ attached sheet II

TRX SMD-Y1.CAP

Capacitance Range and T.C Differentiation (Unit:pF)

1

1

T.C	0	1000	2200	00	00
2 ()					
2 ()					
2 ()					
				00 .	
			- 0	12	
				0/ 12 / 21	

1000

100

1000 . ,

100 .

 TRX 专注电容器廿年	SMD Y2 a.c. ceramic capacitors			
	/Number	-0 2	/Date	2020-02-10
	/Edition	0	/Page	

/

1.

2.

.

.

.

.

.

----- -1

.

----- 1

.

----- 1

10.

----- 1

11.

----- 1 -1

12.

----- 1

 TRX 专注电容器廿年	SMD Y2 a.c. ceramic capacitors			
	/Number	-0 2	/Date	2020-02-10
	/Edition	0	/Page	

1. /Product Name

T **G** **Y2** **102** **K** **B**
 ① ② ③ ④ ⑤

.



①

②













③ 2

④ 102

 TRX 专注电容器廿年	SMD Y2 a.c. ceramic capacitors			
	/Number	-0 2	/Date	2020-02-10
	/Edition	0	/Page	

/Explanation	
	/ /
	- 2 - 2
	() / () / ()
102	(0- 00 1- 2)
	/ (10%) / (20%)
1 0	1 1
 00	2 2
0 12	

3. /Date code

		2020		1	01	1	01	1	1
		2021		2	02	2	02	1	1
2010		2022						1	1
2011		20			0		0	1	1
2012		202			0		0	20	20
20		202			0		0	21	21
201		202			0		0	22	22
201		202			0		0		
201		202			0		0	2	2
201		202		10	10	10	10	2	2
201				11	11	11	11	2	2
201				12	12	12	12	2	2
								2	2
						1	1	2	2
						1	1	 0	 0
								 1	 1

3. /Certificates

certificates			
/	/ -1	1 1	00 (. . .)
	/ .1 -201	200012 0 0	00 (. . .)
	-1 20 / 1 201	- 1	00 (. . .)
	-1	-210	2 0 (. . .)

5. /Product structure

.1 /

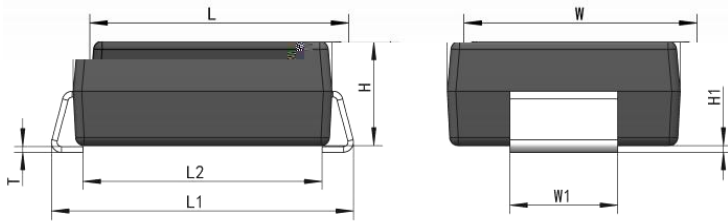

()			
	.0 0.		. 0.
1	.0 0.	2	. 0.
	0.1	1	2. 0.0
1	0.1 0.0		0. 0.02

.2 /

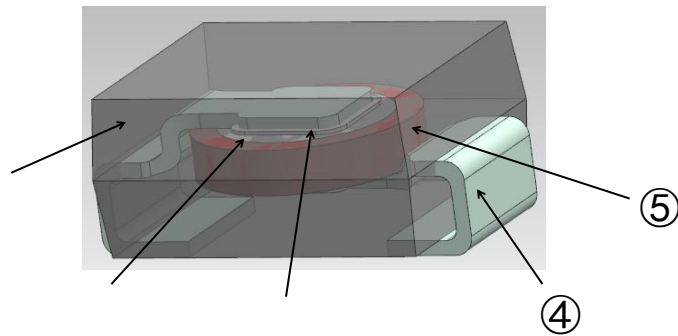

.		
①		(-0) (-0)
②		
③		- -
④		
⑤		

 TRX 专注电容器廿年	SMD Y2 a.c. ceramic capacitors			
	/Number	-0 2	/Date	2020-02-10
	/Edition	0	/Page	

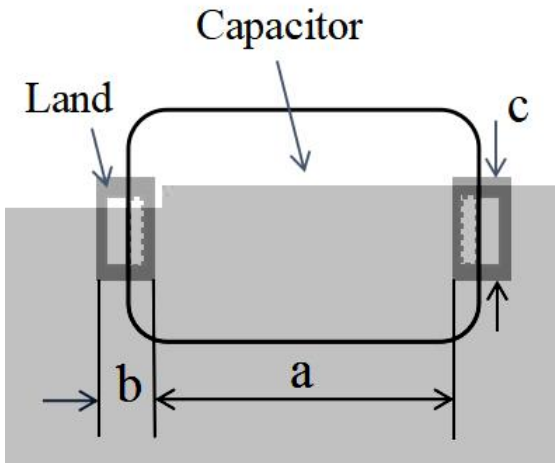

11

10%

1 %

1 %

2. %

12

()

$\Delta (- 0) / 0$

$\Delta 10\%$

$\Delta 1 \%$

$\Delta 1 \%$

000

$\Delta (- 0) / 0$

$\Delta 10\%$

$\Delta 1 \%$

$\Delta 1 \%$

000

/ 0.

10

10

2

2 2

2 2

/

/

10

0.1

10

1000

%

%.

2 2

2 2

/

/

/

/

/

/

/

/

/

/

/

/

/

/

/

/

/

/

/

/

2

2

2

2

2

2

2

2

2

2

2

2

2

2

2

2

2

2

2

2

2

2

2

2

2

2

2

2

2

2

2

2

2

2

2

2

2

2

2

2

2

2

2

2

2

2

2

2

2

2

2

2

2

2

2

2

2

2

2

2

2

2

2

2

2

2

2

2

2

2

2

2

2

2

2

2

2

2

2

2

2

2

2

2

2

2

2

2

2

2

2

2

2

2

2

2

2

2

2

2

2

2

2

2

2

2

2

2

2

2

2

2

2

2

2

2

2

2

2

2

2

2

2

2

2

2

2

2

2

2

2

2

2

2

2

2

2

2

2

2

2

2

2

2

2

2

2

2

2

2

2

2

2

2

2

2

2

2

2

2

2

2

2

2

2

2

2

2

2

2

2

2

2

2

2

2

2

2

2

2

2

2

2

2

2

2

2

2

2

2

2

2

2

2

2

2

2

2

2

2

2

2

2

2

2

2

2

2

2

2

2

2

2

2

2

2

2

2

2

2

2

2

2

2

2

2

2

2

2

2

2

2

2

2

2

2

2

2

2

2

2

2

2

2

2

2

2



TRX
 专注电容器廿年

SMD Y2 a.c. ceramic capacitors

/Number

-0 2

/Date

2020-02-10

/Edition

0

/Page



1



1

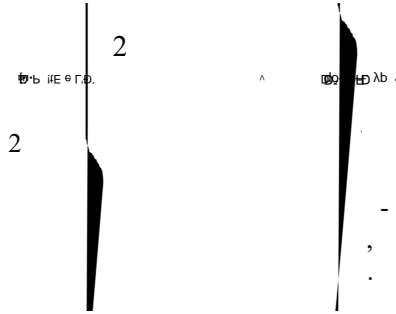

10

2

2

1

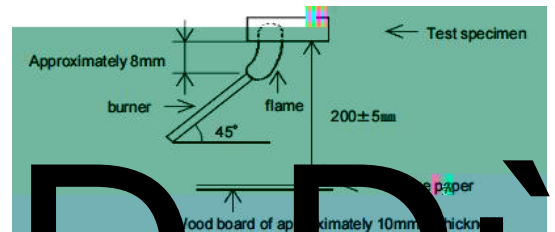

R Ө ã v p Ө D ù

 TRX 专注电容器廿年	SMD Y2 a.c. ceramic capacitors			
	/Number	-0 2	/Date	2020-02-10
	/Edition	0	/Page	1

1	0 %	0 %	0 %	0 %
1	0 %	0 %	0 %	0 %

8. /Capacitor temperature characteristic

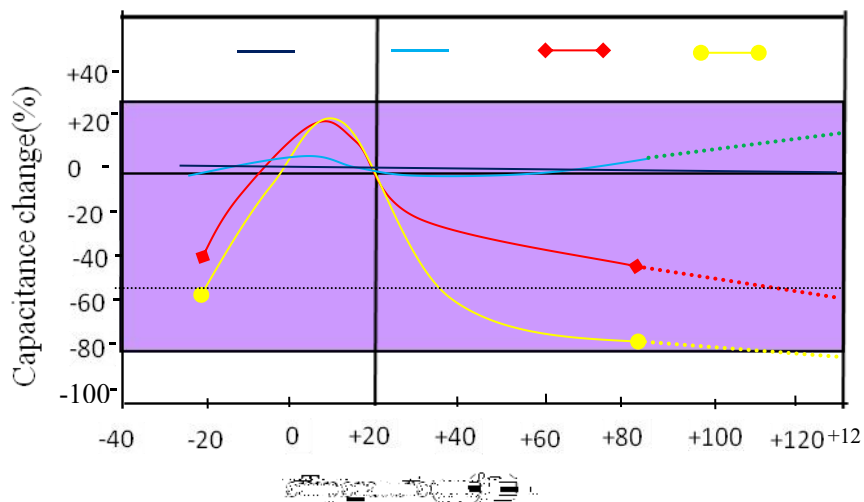

11. /Product packaging

11.1 /

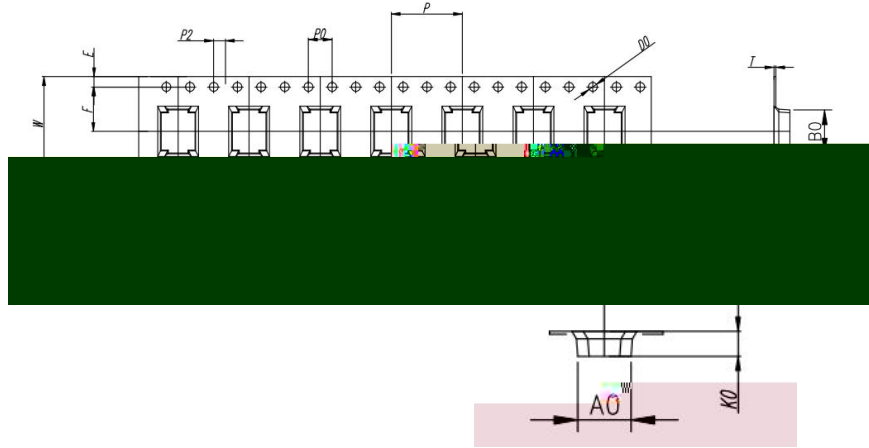

未标注斜角为: 5°.

ITEM	W	A0	B0	K1	K0	P	F	E	DO	D1	P0	P2	T
DIM	16.0 $\begin{smallmatrix} +0.30 \\ -0.30 \end{smallmatrix}$	5.70 $\begin{smallmatrix} +0.10 \\ -0.10 \end{smallmatrix}$	7.30 $\begin{smallmatrix} +0.10 \\ -0.10 \end{smallmatrix}$	---	2.70 $\begin{smallmatrix} +0.10 \\ -0.10 \end{smallmatrix}$	12.0 $\begin{smallmatrix} +0.10 \\ -0.10 \end{smallmatrix}$	7.50 $\begin{smallmatrix} +0.10 \\ -0.10 \end{smallmatrix}$	1.75 $\begin{smallmatrix} +0.10 \\ -0.10 \end{smallmatrix}$	1.5 $\begin{smallmatrix} +0.10 \\ -0.10 \end{smallmatrix}$	0.00 $\begin{smallmatrix} +0.10 \\ -0.10 \end{smallmatrix}$	4.0 $\begin{smallmatrix} +0.10 \\ -0.10 \end{smallmatrix}$	2.0 $\begin{smallmatrix} +0.10 \\ -0.10 \end{smallmatrix}$	0.30 $\begin{smallmatrix} +0.05 \\ -0.05 \end{smallmatrix}$
ALTERNATE													

11.2 /

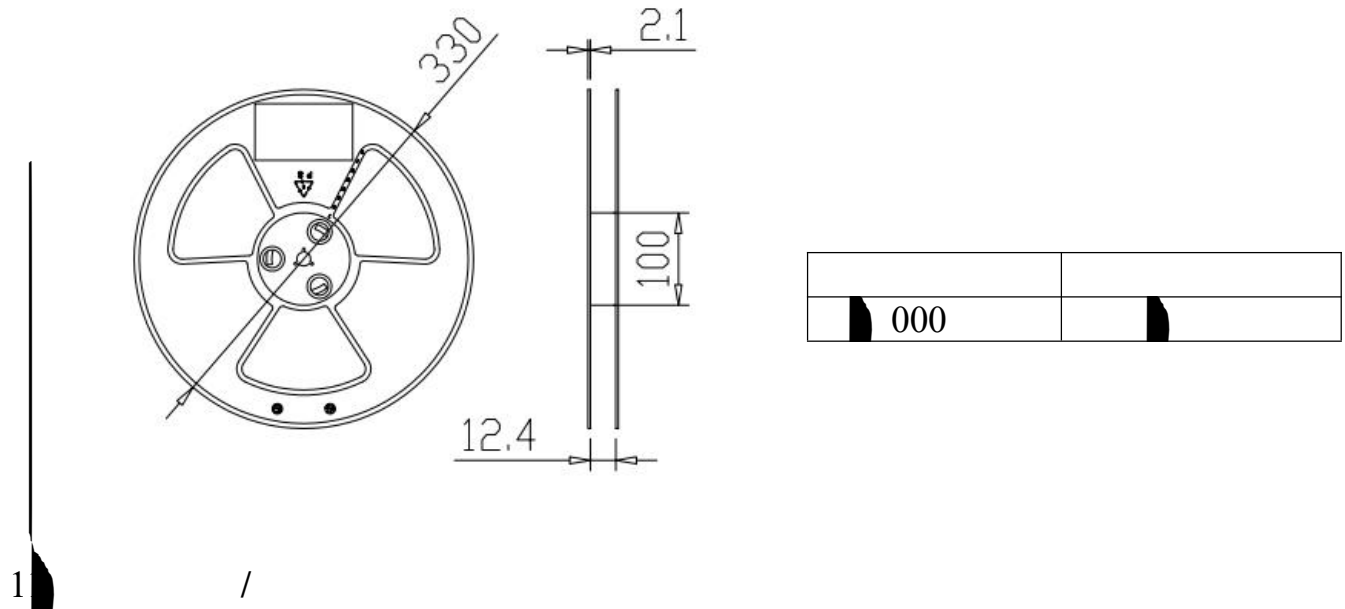



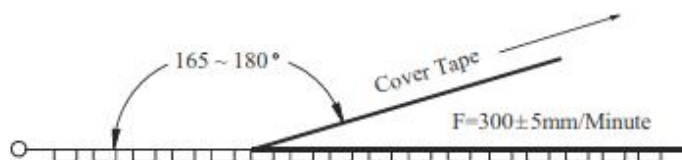



Item	Data	Remark
Cover tape adhesion	10 ~ 100g	Carrier tape and cover tape open angle 165 ~ 180° F=300± 5mm/minute

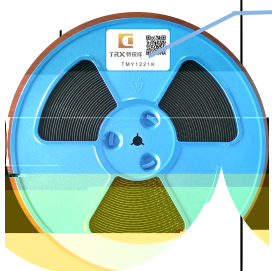



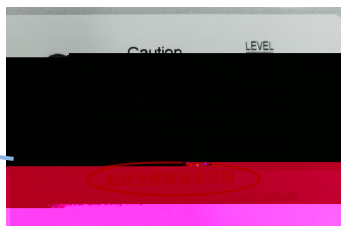

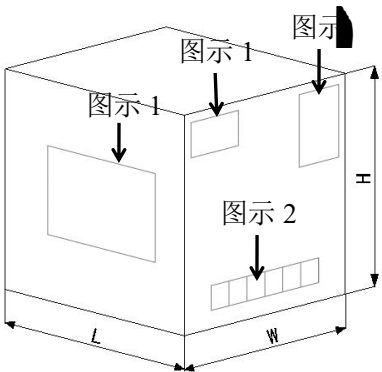
 TRX 专注电容器廿年	SMD Y2 a.c. ceramic capacitors			
	/Number	-0 2	/Date	2020-02-10
	/Edition	0	/Page	1

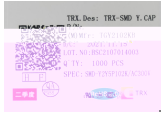
11. /

/inner-packaging			
 <p>标签/</p>	 <p>料号</p>		
			

/Outer-packaging			
			
图示 1/ 1 图示 2/ 2 图示 / /			
()			
		2	1 .0

/Package sketch:			
			
/	1 / / /	(/ /) (/ /)	(/ /) (/ /)
		1100*1100* 0	1100*1100*1 00

1.	2.	&	
. 0	/	2.	& -
Remark 1.	. 0		

	SMD Y2 a.c. ceramic capacitors			
	/Number	-0 2	/Date	2020-02-10
	/Edition	0	/Page	1

12. /Application notes

①.

②.

()

③.

④.

⑤.

⑥.